

# **MEGALARM®**

## ***MEGA 250***

REMOTE ENGINE STARTER WITH  
KEYLESS ENTRY

Installation Manual



***MEGATRONIX***  
CHATSWORTH, CA U.S.A.



## INTRODUCTION

### INSTALLER WARNINGS

This Remote Starter with Alarm System is designed to be installed on fuel injected vehicles with an automatic transmission ONLY.

- Never install this remote starter on a manual transmission vehicle.
- This system must be installed and wired through a safety switch it will not start in any forward or reverse gear.
- Some automatic transmission vehicle [mainly older GM vehicles with a purple starter wire] have a mechanical-type park safety switch instead of electrical safety switch. The mechanical type does not interrupt the starter circuit when the transmission is any gear and does not offer the 100% level of safety required for remote starting purposes. Therefore, our system should never be installed on any vehicle that uses a mechanical type park safety switch.
- Once you install this system, you must verify that the vehicle will not start any forward or reverse gear. Regardless of the type of vehicle.
- Read operation manual for operating and programming routine.
- Do not install any component near the brake, gas pedal or steering linkage.
- Some vehicles have a factory installed transponder immobilizer system that can severely complicate the installation. There is possibility that this system can not be installed on some immobilizer equipped vehicles.
- Most vehicles have an SRS air bag system. Use extreme care and do not probe any wires of the SRS system.
- Disconnect the car battery before connecting work on the vehicle.
- Check behind panels before drilling any holes. Ensure that no wiring harness or other components are located behind the panels that would otherwise be damaged.
- Use conventional crimp lock, bullet on any wiring. Poor wiring, i.e. taped joints will possibly introduce unreliability into the alarm system and may result in false alarms or incorrect operation.
- Install wiring neatly under carpets or behind trim to prevent possible damage to wires.
- For the wire operates the current more than 10A. We suggest soldering all connection point. Do not use crimp lock type connectors or wire nuts.

# INSTALLATION DIAGRAM

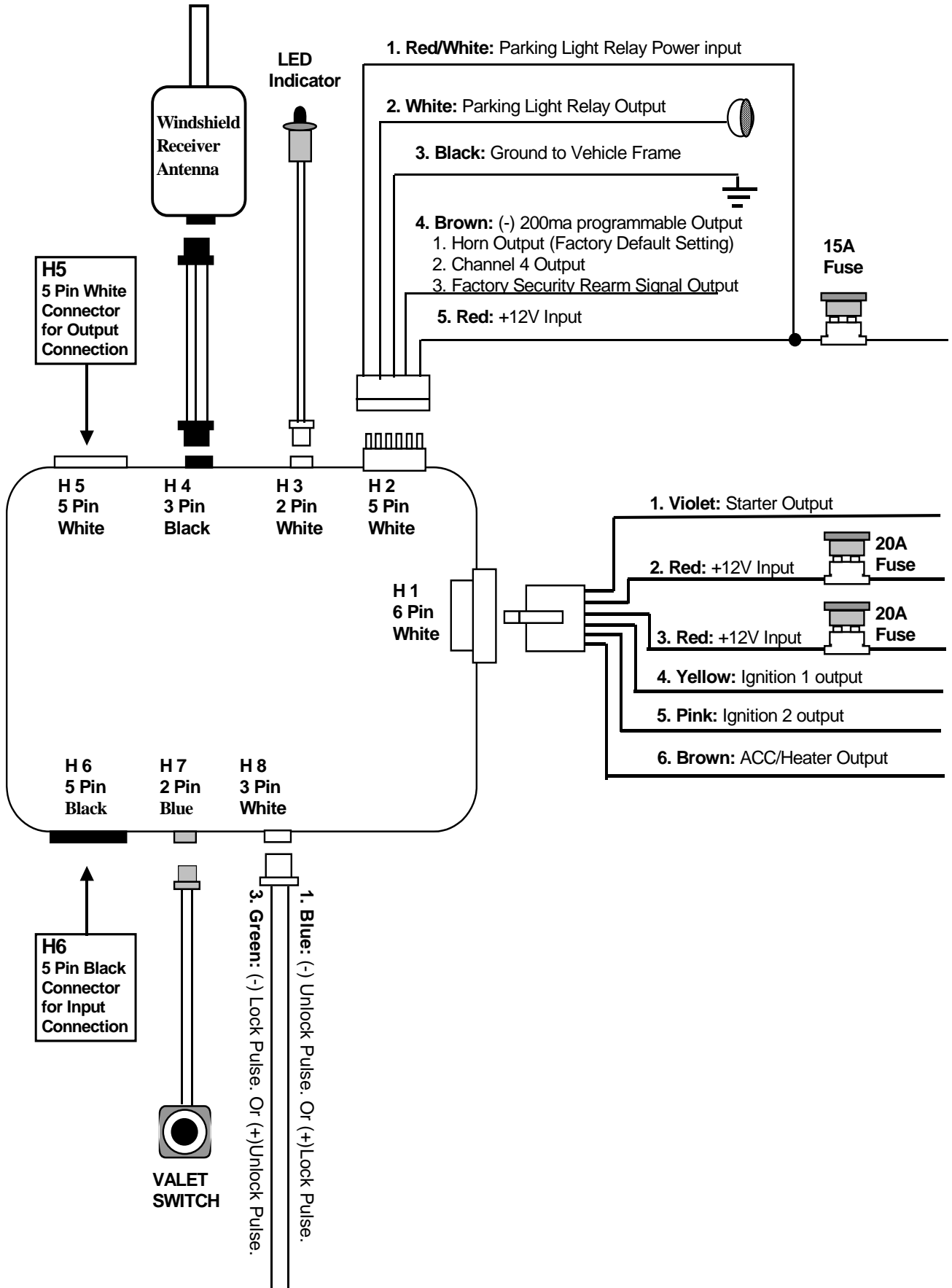

## #H5 5 PIN WHITE CONNECTOR FOR OUTPUT CONNECTION

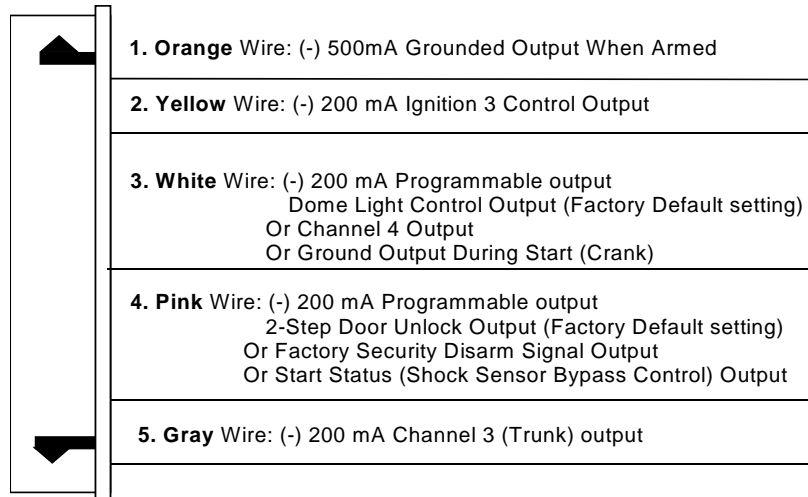

## #H6. 5 PIN BLACK CONNECTOR FOR INPUT CONNECTION:

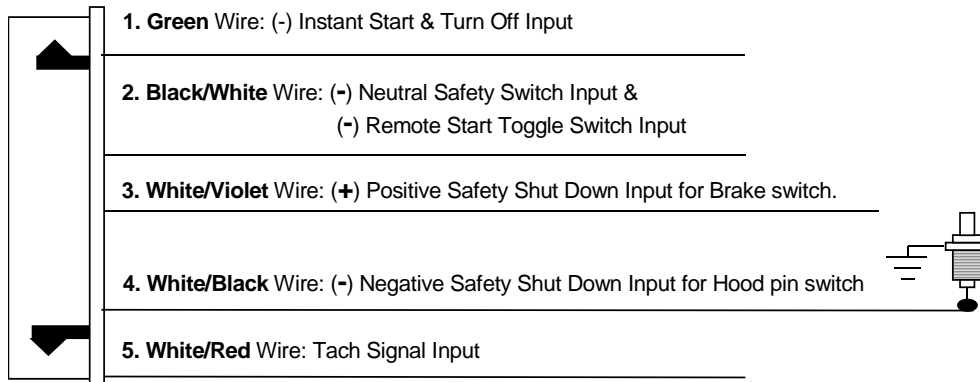

**IMPORTANT NOTE:** Directly connect the H6/2 BLACK/WHITE wire to the "GROUND" when this wire is not used.

## WIRING

Keep wiring away from moving engine parts, exhaust pipes and high-tension cable. Tape wires that pass through holes on the firewall to prevent fraying. Watch out sharp edges that may damage wires and causes short circuit.

**CAUTION:** Do not connect the wire harness to the control module until all wiring to vehicle is complete.

### H1: 6 PIN HEAVY GAUGE WIRING CONNECTION:

Remember that the system does to start a vehicle is duplicate the functions of the ignition key switch! Below, we will explain the three basic functions of the ignition switch. Since this installation will require analysis of the ignition switch functions, we recommend making the three connections below at the ignition switch harness directly.

#### H1/1. Violet Wire—Starter Output

Careful consideration for the connection of this wire must be made to prevent the vehicle from starting while in gear. Understanding the difference between a mechanical and an electrical Neutral Start Switch will allow you to properly identify the circuit and select the correct installation method. In addition you will realize why the connection of the safety wire is required for all mechanical switch configurations.

Failure to make this connection properly can result in personal injury and property damage.

In all installations it is the responsibility of the installing technician to test the remote start unit and assure that the vehicle can not start via RF control in any gear selection other than park or neutral.

In both mechanical and electrical neutral start switch configurations, the connection of the VIOLET wire will be made to the low current start solenoid wire of the ignition switch harness. This wire have +12 volts when the ignition switch is turned to the "START" (CRANK) position only. This wire have 0 volts in all other ignition switch positions.

**NOTE:** This wire must be connected to the vehicle side of the starter cut relay (when used). For the electrical neutral switch configuration, this connection must be made between the starter inhibit relay (when used) and the neutral safety switch as shown in the following diagram.

Failure to connect this wire to the ignition switch side of the neutral safety switch can result in personal injury and property damage. SEE NEUTRAL START SAFETY TEST FOR FURTHER DETAILS.

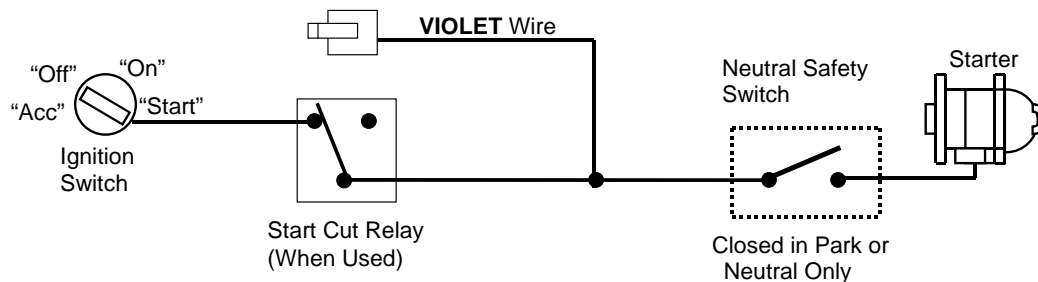

#### H1/2 & H1/3. Red Wire (2)-- +12V Power Input

Remove the two 20A fuses prior to connecting these wires and do not replace them until the satellite has been plugged into the control module. These wires are the source of current for all the circuits the relay satellite will energize. They must be connected to a high current source. Since the factory supplies (+) 12V to the key switch that is used to operate the motor, it is recommended that these wires be connected there.

Note: If the factory supplies two separate (+) 12V feeds to the ignition switch, connect one RED wire of the satellite to each feed at the switch.

#### H1/4. Yellow Wire – Ignition 1 Output

Connect the YELLOW wire to the ignition 1 wire from the ignition switch. The ignition wire should receive "12 volts" when the ignition key is in the "ON" or "RUN" and "START" or "CRANK" position. When the ignition is turned "OFF", the ignition wire should receive "0" voltage.. **The YELLOW wire must be connected.**

#### H1/5. PINK Wire – Ignition 2 Output

Some vehicles have [2] ignition wires that must be power. Connect the PINK wire to the ignition 2 wire from the ignition switch. The ignition wire should receive "12 volts" when the ignition key is in the "ON" or "RUN" and "START" or "CRANK" position. When the ignition is turned "OFF", the ignition wire should receive "0" voltage. If the PINK wire is not used, cap the end of the wire.

#### H1/6. Brown Wire –Accessory Output (Heater /ACC Output)

Connect the BROWN wire to the accessory wire in the vehicle that powers the climate control system.

An accessory wire will show + 12 volts when the ignition switch is turned to the "ACCESSORY" or "ON" and "RUN" positions, and will show 0 Volts when the key is turned to the "OFF" and "START" or "CRANK" position. There will often be more than one accessory wire in the ignition harness. The correct accessory wire will power the vehicle's climate control system. Some vehicle may have separate wires for the blower motor and the air conditioning compressor. In such cases, it will be necessary to add a relay to power the second accessory wire.

### H2: 5 PIN WIRE HARNESS:

#### H2/1. RED / WHITE Wire –PARKING LIGHT RELAY INPUT --

The RED/WHITE wire is the input to the flashing parking light relay. The connection of the RED/WHITE wire will determine the output polarity of the flashing parking light relay.

If the vehicle you are working on has +12volt switched parking lights, you don't need connect this wire. This wire already connected to +12volt.

If the vehicle's parking lights are ground switched, cut the RED/WHITE wire, connect the RED/WHITE wire to chassis ground.

#### H2/2. WHITE Wire -- PARKING LIGHT RELAY OUTPUT (+12 V 10A OUTPUT) --

Connect the WHITE wire to the parking light wire coming from the headlight switch. Do not connect the WHITE wire to the dashboard lighting dimmer switch. (Damage to the dimmer will result). The limitation of the WHITE wire is 10 AMP max. Do not exceed this limit or damage to the alarm and parking relay will result.

#### H2/3. BLACK Wire -- SYSTEM GROUND –



This is main ground connection of the alarm module. Make this connection to a solid section of the vehicle frame. Do not connect this wire to any existing ground wires supplied by the factory wire loom, make the connection to the vehicle's frame directly.

#### H2/4. BROWN Wire – (-) 200mA PROGRAMMABLE OUTPUT (See Alarm Feature I - 4 Programming)

##### HORN OUTPUT – (Factory Default Setting)

This wire is provided to use the existing vehicle's horn as the alarm system's optional's warning audible device. It's a transistorized low current output, and should only be connected to the low current ground output from the vehicle's horn switch.

##### CHANNEL 4 OUTPUT– (See Alarm Feature I - 4 Programming)

Press  and  buttons at the same time to remote control the optional electrical device. The device will 'on' when the button(s) press continuously, and 'off' when the button(s) released.

**FACTORY SECURITY REARM SIGNAL OUTPUT– (See Alarm Feature I - 4 Programming)**

This wire is designed to rearm a factory installed security system. This wire will supply a pulse whenever the remote start times out or is shut down using the transmitter and remote door locking..

**H2/5. RED Wire -- SYSTEM POWER (+12V CONSTANT) --**

The RED wire supplies power to the system. Connect this wire to a constant +12 volt source.

**H3. 2 PIN WHITE CONNECTOR FOR THE LED STATUS INDICATOR:**

The led indicator status should be mounted in a highly visible area such as top of the dashboard, on top of the shifter console or on dashboard face. Leave at least 6mm space behind the mounting location for LED housing. Once a suitable location is chosen, drill a 6mm hole. Run the LED wires through the hole then press the 2 pin LED housing into the place. Route the LED wires to the control module.

**H4. BLACK 3-PIN CONNECTOR. – Windshield Receiver /Antenna**

The windshield receiver/antenna mounts on the windshield (Inside). We suggest you mount it on the lower left or upper left-hand side of windshield.

Warning! Do not mount in such a manner that it obstructs the driver's view.

- The receiver/antenna whip must be vertical.
- Remove the protective tape backing.
- Carefully align the receiver/antenna and apply to windshield.
- Route the black connector wire behind the trim and connect to receiver/antenna.
- Connect the other end to the control module.
- Special considerations must be made for windshield glass as some newer vehicles utilize a metallic shielded window glass that will inhibit or restrict RF reception. In these vehicles, route the windshield receiver/antenna module away from metallic shielded window glass as far as possible.

**H5: 5-PIN MINI WHITE CONNECTOR WIRE HARNESS:**

**H5/1 ORANGE Wire – (-) 500ma GROUNDED OUTPUT WHEN ARMED --**

This wire will become grounded when the alarm is armed. The current capacity of this wire is 200mA. This output can control starter disable, when an intrusion is detected and the system is triggered. The vehicles prevent from any unauthorized starting.

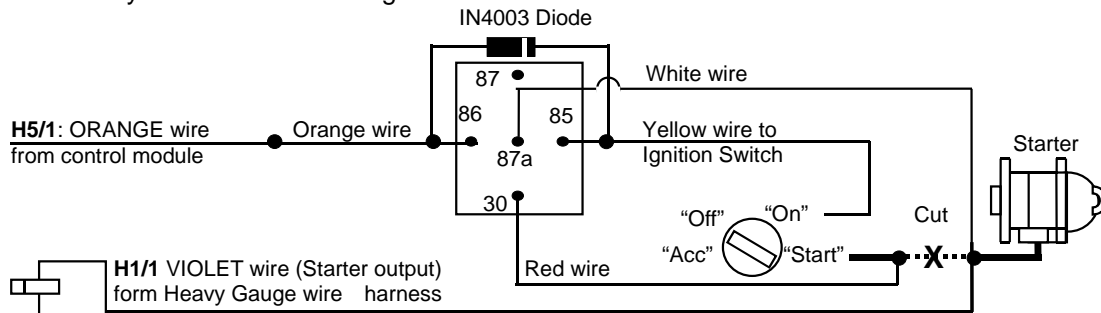

**H5/2. YELLOW Wire:- (-) 200ma IGNITION 3 OUTPUT–**

This wire provides a 200mA (-) ground output that becomes active 4 seconds before the remote start unit initialize, and remains grounded while running.

**Ignition 3 output:**

Some newer vehicles use a third ignition wire which is required to start and keep the vehicle's engine running. If this is the case, wire an IGN 3 relay (not supplied) as shown below:

Do not connect any vehicle circuits together, they are isolated for a reason.

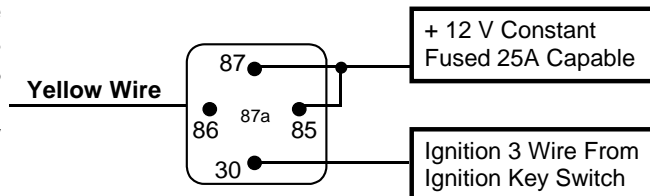

**Transponder interfacing using relay:**

If the vehicle has transponder system installed, you will need to by-pass the system while the vehicle is operating under the control of the Remote Start Unit. To do this:

1. You will need a transponder key that's already programmed to the vehicle.
2. Remove the trim around the ignition switch.
3. Wrap a thin (28 - 30awg) wire tightly around ignition switch 6 to 8 times and secure it.
4. About 6" down line make another loop of approximately 2" diameter.
5. Place the key inside this loop and secure it to the loop.
6. Connect on end of the (28 - 30awg) wire to pin (87) of the relay module.
7. Connect the other end of the loop wire to Pin (30) of relay module.

8. Connect the pin (86) of the relay module to the ignition wire from the ignition switch.
9. connect the pin (85) of the relay module to the H5/2 Yellow wire of 5-pin mini white connector.

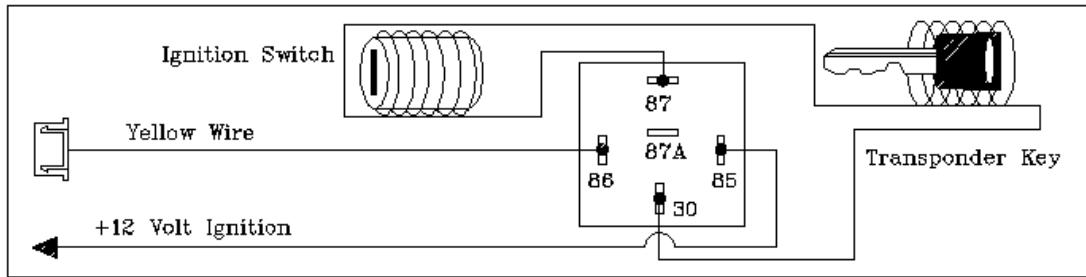

### GM VATS KEY OVERRIDE:

If the vehicle has the General Motor VATS system installed, you will need to by-pass the system while the vehicle is operating under the control of the Remote Start Unit. To do this:

1. Measure the resistance of the resistor pellet on the ignition key then select a resistor within 5% of the key's value.
2. Locate the pair of VATS wires in the vehicle, usually a pair of thin gauge wires running from the ignition switch to the VATS control module.
3. Connect the YELLOW wire from Remote Start Unit to TERMINAL #85 of an external relay. Connect terminal #86 of the relay to a fused +12 volt.
4. Cut (#1) wire (as shown), and connect the ignition switch side of the cut wire to terminal #87a of the relay. Connect the other side of the (#1) wire to terminal #30.
5. Connect the previously selseed resistor from terminal #87 to the second(#2) wire (as shown).

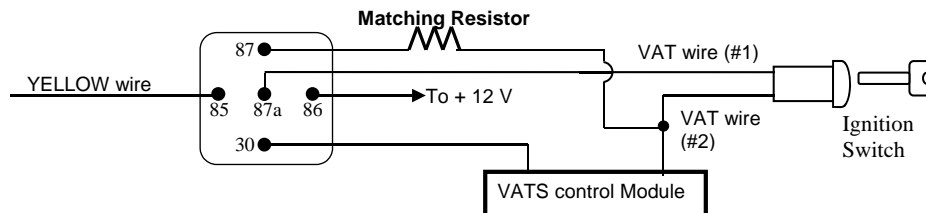

### H5/3. WHITE Wire – (-) 200ma PROGRAMMABLE OUTPUT(See Alarm Feature I - 4 Programming) DOME LIGHT CONTROL OUTPUT (Factory Default Setting)—

This wire becomes grounded when the dome light controls circuit active. The current capacity of this wire is 200mA. This wire can control the operation of the interior lights. An optional 10 Amps relay can be used to this system for interior lights operation.

- a). Upon disarming, the interior lights will remain on for 30 seconds.
- b). If the vehicle is violated, the interior light will flash for the same duration as the siren.

### CHANNEL 4 OUTPUT– (See Alarm Feature I - 5 Programming)

Press and buttons at the same time to remote control the optional electrical device. The device will 'on' when the button(s) press continuously, and 'off' when the button(s) released.

### GROUND OUTPUT DURING START (CRANK) – (See Alarm Feature I - 5 Programming)

This wire will provide a 200mA ground output while the starter output of the remote start unit is active. This output can be used to activate the Crank Low/Bulb Test wire found in some GM vehicles. This wire is also referred to as the ECM wake up wire in some vehicles.

### H5/4. PINK Wire – (-) 200ma PROGRAMMABLE OUTPUT(See Alarm Feature I - 3 Programming) 2 STEPS UNLOCK OUTPUT (Factory Default Setting) --

The 2 steps unlock feature will work for the most fully electronic door lock circuit. The vehicle must have an electronic door lock switch (not the lock knob or key switch), which locks and unlocks all of vehicle's doors. When wired for this feature, press the disarm (or unlock) button one time will disarm the alarm and unlock the driver's door only. If, press disarm (or unlock) button two times within 3 seconds, the alarm will disarm and all doors will unlock.

### FACTORY SECURITY DISARM SIGNAL OUTPUT –

This wire is designed to disarm a factory installed security system. This wire sends a negative (-) 1 seconds pulse upon a remote start and remote door unlocking. Some factory systems must be disarmed to allow remote starting. In most cases, this wire may be connected directly to the factory alarm disarm wire. The correct wire will show nagative ground when the key is used to unlock the doors or trunk. This wire is usually found in the kick panel area in the wiring harness coming into the car body from the door.

### START STATUS (Shock Sensor Bypass Control) OUTPUT–

This wire is designed to by-pass shock sensor module. This wire will supply an output at all times the remote start is operating plus an additional 3 seconds after the remote start unit turn off.

### H5/5 . GRAY Wire – (-) 200ma CHANNEL 3 (TRUNK) OUTPUT



This will become a 1 second pulse ground by activate channel 3 on transmitter for two seconds, the current capacity of this wire is 200 mA. This feature allows you to remote control trunk release or other electric device.

### H6: 5 PIN MINI BLACK CONNECTOR :

H6/1. GREEN Wire – (-) INSTANT START & TURN OFF INPUT –(See Alarm Feature II - 4 Programming)

This wires activates and turns off the remote starter each time it sees a momentary ground signal. Normally only used for testing during installation or when activating the module from an after-market system.

H6/2. BLACK/WHITE Wire —(-)Remote Start Enable Toggle Switch Input —  
— (-)Neutral Safety Switch Input —

When the BLACK/WHITE wire is grounded, the remote start unit is operable. When this wire is open from ground, the remote start is disable.

1. The optional “remote start toggle switch” can be added on to temporarily disable the Remote Start Device, it can prevent the vehicle from being remote started accidentally. This feature is useful if the vehicle is being serviced or stored in an enclosed area. To disable the remote start, move the optional remote start enable toggle switch to the OFF position. To enable the remote start, move the optional remote start enable toggle switch to the ON position.
2. If needed, This wire can connect to the PARK/NEUTRAL switch in the vehicle. (See the TESTING YOUR INSTALLATION GUIDE)

**IMPORTANT NOTE: Directly connect the BLACK/WHITE wire to the “GROUND” when this wire is not used.**

H6/3. WHITE/VIOLET Wire – POSITIVE SAFETY SHUT DOWN INPUT

This wire provides an instant shutdown for the remote start, whenever it gets +12volts. If the brake lights switch in the vehicle switches +12 volts to the brake light circuit, connect this wire to the output side of the brake switch. This will allow the remote start to shut down if an attempt is made to operate the vehicle without the key while running under the control of the remote start. In most vehicles, in order to shift gear, the brake pedal must be depressed. The brake input will in turn cause the remote start unit to shut off. See below diagram.

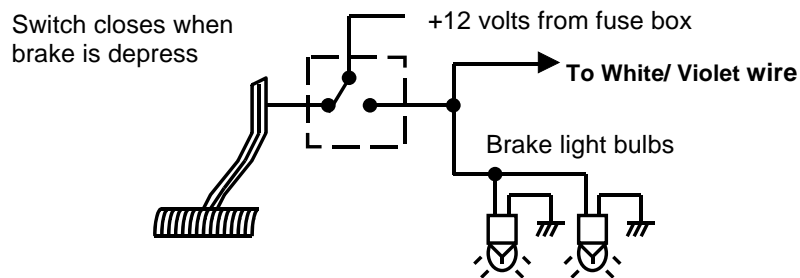

H6/4. WHITE/BLACK Wire – NEGATIVE SAFETY SHUT DOWN INPUT --

The WHITE/BLACK wire provides an instant shutdown for the remote start, whenever it is grounded. Connect the wire to the hood pin switch previously installed. This wire must be routed through a grommet in the firewall and connected to the hood pin switch.

**Important!** This connection is a safety wire and must be connected as shown and tested as specified. Failure to do so may result in personal injury or property damage. See detail of wiring in the following diagram. This wire may also be used if the vehicle brake light circuit switches ground to the brake lights. An isolation diode must be used for ground switched brake light circuits and must be connected to the output of the brake switch.

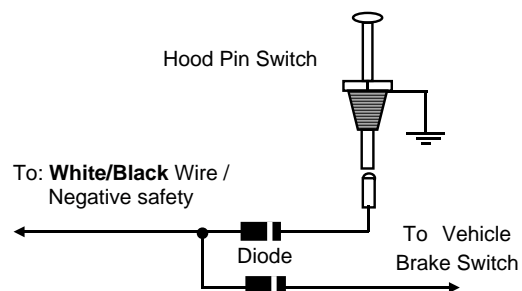

H6/5. WHITE/RED Wire —Tach Signal connection—

Note: You should connect this wire if you program the Start Feature II – 2 to “Engine checking TACH.” otherwise not to connect this wire and tap the end.

Note: No connection of this wire is required, if you use the voltage or timer checking type mode.

This input provides the remote start system with information about the engine’s revolutions per minute (RPM). It can be connected to the negative side of the coil in vehicle with conventional coils. In multi-coil and high energy ignition system locating a proper signal may be more difficult. Once connected, To test for a tach. wire, a multi-meter capable of test AC voltage must be used. The tach. wire will show between 1V and 6V AC at idle, and will increase as engine RPM increases. In multi-coil ignition system, the system can learn individual coil wire. Individual coil wires in a multi-coil ignition system will register

lower amounts of AC voltage. Also, if necessary, the system can use a fuel injector control wire for engine speed sensing. Common locations for a tach. wire are the ignition coil itself, the back of the gauges, engine computers, and automatic transmission computers.

**IMPORTANT!** Do not test tach. wires with a test light or logic probe. The vehicle will be damaged.

How to find a tachometer wire with your multi-meter

1. Set the ACV or AC voltage (12V or 20V is fine.)
2. Attach the (-) probe of the meter to chassis ground.
3. Start and run the vehicle.
4. Probe the wire you suspect of being the tach. wire with the red probe of the meter.
5. If this is the correct wire the meter will read between 1V and 6V.

**IMPORTANT NOTE: You must program the "Tach Signal" before trying to remote start.**

### H7. 2 PIN BLUE CONNECTOR FOR THE VALET SWITCH:

Select a mounting location for the switch that is easily accessible to the driver of the vehicle. The switch does not have to be concealed, however, concealing the switch is always recommended, as this provides an even higher level of security to the vehicle. Mount the valet switch in a hidden but accessible location.

Route the valet switch wires to the control module.

### H8. 3 PIN DOOR LOCK CONNECTOR:

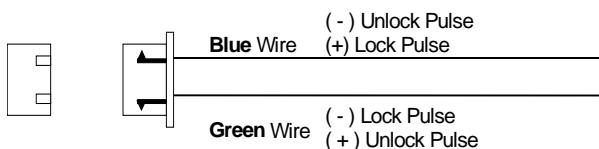

#### INSTALL NEW DOOR LOCK MOTOR

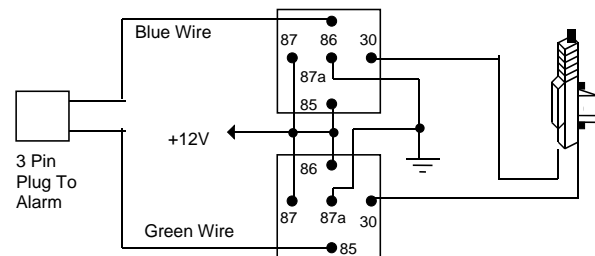

#### NEGATIVE TRIGGER DOOR LOCK SYSTEM

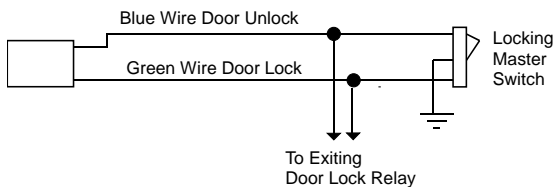

#### POSITIVE TRIGGER DOOR LOCK SYSTEM

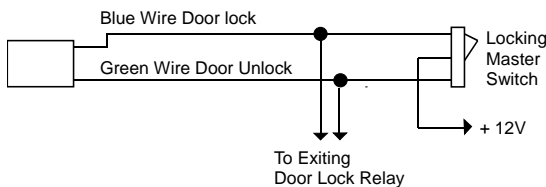

#### 5-WIRE ALTERNATING DOOR LOCK

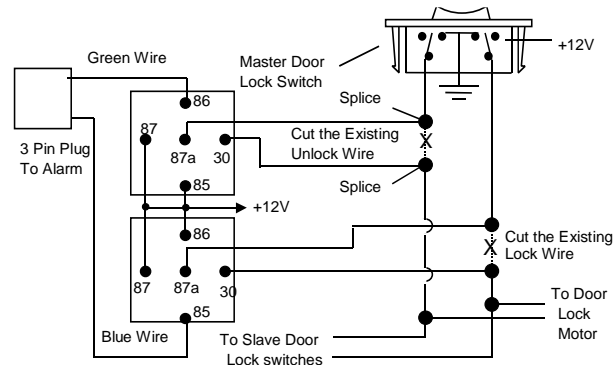

#### VACUUM OPERATED CENTRAL LOCKING

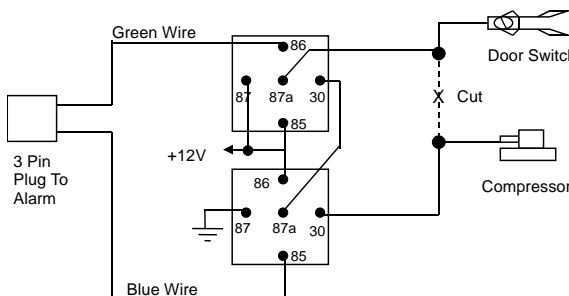

## 2 STEP DOOR UNLOCK WIRE CONNECTION FOR 5 WIRE ALTERNATING DOOR LOCKS

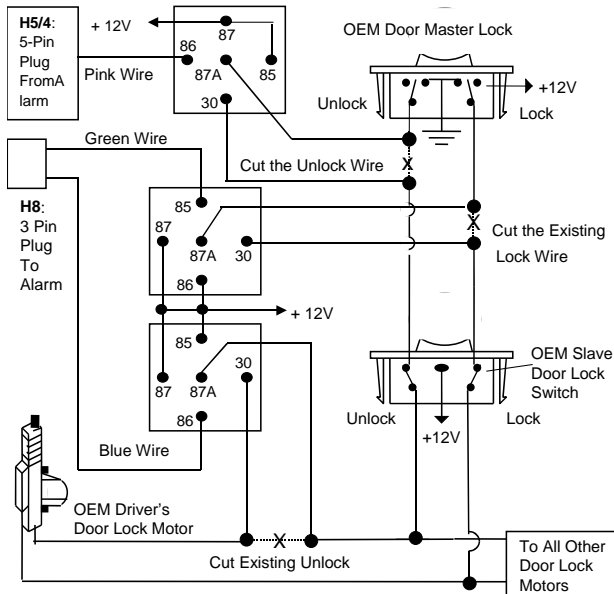

## 2 STEP DOOR UNLOCK WIRE CONNECTION FOR GROUND SWITCHED DOOR LOCKS

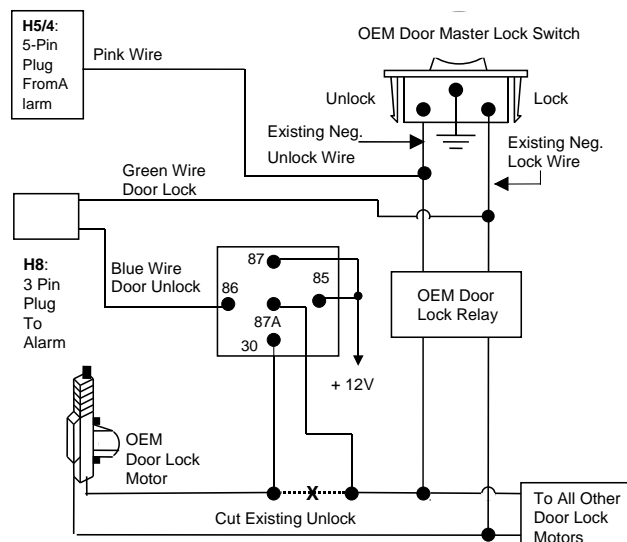

## VACUUM OPERATED DOOR LOCKING SYSTEM:

TYPICAL OF MERCEDES BENZ AND AUDI.

Locate the wire under the driver's kick panel. Use the voltmeter connecting to ground, verify that you have the correct wire with the doors unlocked, the voltmeter will receive "12 volts". Lock the doors and the voltmeter will read "0 volt". Move the alligator clip to +12V and the voltmeter will receive "12 volts". Cut this wire and make connections. Be sure to program door lock timer to 3.5 seconds. (See Alarm Feature II – 1 Programming.)

## 2 STEP DOOR UNLOCK WIRE CONNECTION FOR POSITIVE SWITCHED DOOR LOCKS

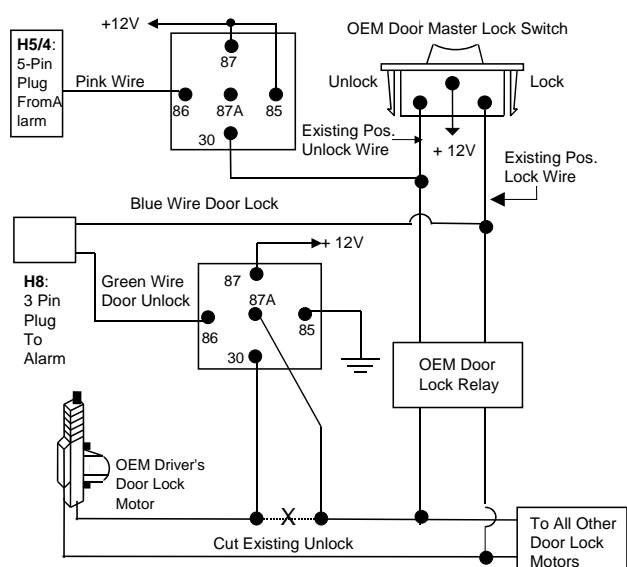

## PROGRAMMING

### A. PROGRAMMING THE REMOTE TRANSMITTER:

**Note:** This mode will only retain the last 4 remote transmitters programmed. If the transmitter memory is exceeded, the security system will start deleting transmitters from memory in chronological order.

1. Turn the Ignition 'switch' 'OFF/ON' 3 TIMES and stay in ON position. Within 15 seconds.
2. Push the Valet switch 3 times and holding in on 3rd push until a long chirp is hearing and the LED start to flash then release the valet switch. You are now in the Transmitter programming mode.
3. Press and hold any button of the transmitter until the siren responds with a confirming chirp/ a flash from parking light / the LED turns on for 2 seconds indicating the signal has been stored into memory.
4. If you have additional transmitters (up to 4) that need to be programmed, repeat step 3 for each transmitter.

**Exit:** Turn Ignition to 'OFF' position, or leave it for 15 seconds. A 3 long chirps & 3 parking light flashes to confirm exit.

### B. ALARM FEATURES PROGRAMMING:

#### ALARM FEATURE "I" PRORAMMING:

1. Turn the Ignition 'switch' 'ON/OFF' 3 TIMES and stay in OFF position.

2. Push the Valet switch **2** times and holding in on **2<sup>nd</sup>** push until **one** chirp with a long chirp is hearing and the LED start to flash then release the Programming switch. You are now in the feature 'I' programming mode.
3. Press and release the transmitter button 'A' corresponding to the feature 'A' you want to program.
  - a. The horn chirps and LED pause will indicate newly setting.
  - b. The factory default settings is always [2] LED flash, [2] horn chirp.
4. Depress the transmitter button 'A' again to change the feature. Simple keep re-depressing the transmitter button 'A' again until the module advances to your desired setting.
  - a. In this case, Press button 'A' again, the module would advance to [2] LED flash, [2] horn chirp.
  - b. Press button 'A' again, the module would advance to [3] LED flash, [3] horn chirps etc.
5. Depress the transmitter button 'B' corresponding to the feature 'B' you wants to program.

Press Transmitter Button	One Chirp / LED one pulse <b>Factory Default Setting</b>	Two Chirps / LED two pulse	Three Chirps / LED three pulse
1	Chirps on	Chirps off	
2	Pathway illumination feature "off"	Parking light "on" for 30-second upon an unlock signal	Parking light "on" for 30-second upon an unlock signal & 10-second upon a lock signal.
3	H5/4 Pink Wire = 2-Step Door Unlock Output	H5/4 Pink Wire = Factory Security Disarm Signal Output	H5/4 Pink Wire = Start Status (Shock Sensor Bypass Control) Output
4	H2/4 Brown Wire = Horn Output	H2/4 Brown Wire = Channel 4 Output	H2/4 Brown Wire = Rearm Signal Output
5  +	H5/3 White Wire = Dome Light Output	H5/3 White Wire = Channel 4 Output	H5/3 White Wire = Ground Output During Start (Crank)

**Exit:** Turn Ignition to 'ON' position, or leave it for 15 seconds. A 3 long chirps & 3 parking light flashes to confirm exit.

**Ground Output During Start (Crank) =** This wire will provide a 200mA ground output while the starter output of the remote start unit is active. This output can be used to activate the Crank Low/Bulb Test wire found in some GM vehicles. This wire is also referred to as the ECM wake up wire in some vehicles.

### ALARM FEATURE "II" PRORAMMING:

- 1 Turn the Ignition 'switch 'ON/OFF' 3 TIMES and stay in OFF position.
- 2 Push the Valet switch **4** times and holding in on the **4<sup>th</sup>** push until **two** chirps with a long chirp is hearing and the LED start to flash then release the valet switch. You are now in the Alarm feature 'II' programming mode.
- 3 Press and release the transmitter button 'A' corresponding to the feature 'A' you want to program.

Press Transmitter Button	One Chirp / LED one pulse <b>Factory Default Setting</b>	Two Chirps / LED two pulse	Three Chirps / LED three pulse	Four Chirps / LED four pulse
1	0.8-second Door lock pulses.	3.5-second Door lock pulse.	Double pulse unlock	Door lock with "Comfort Feature"
2	Ignition controlled door locks & unlocks	Ignition controlled door locks only	Ignition controlled door unlocks only	Without ignition controlled door locks & unlocks
3	Door lock before start	Door lock after shut-down	Door lock before start and Door lock after shut-down	Without this feature
4	H6/1 Green Wire = 1 Pulse Remote Start	H6/1 Green Wire = 3 Pulse Remote Start		

**Exit:** Turn Ignition to 'ON' position, or leave it for 15 seconds. A 3 long chirps & 3 parking light flashes to confirm exit.

**Comfort Feature:**

Some Vehicles have a special “COMFORT feature”. When you lock the door with the key, you just have to keep on turning the key on the door about 5 or 7 seconds and the window will close directly.  
 If your vehicle with “COMFORT feature” and you wish the door being locked and the window being closed automatically at the same time by remote control, you can set the alarm feature II-1 “with comfort feature”.

**REMOTE START FEATURE PROGRAM MODE.**

**START FEATURE “I” PRORAMMING:**

1. Turn the Ignition 'switch 'ON/OFF' 3 TIMES and stay in OFF position.
2. Push the Valet switch 8 times and holding in on the 8<sup>th</sup> push until **Four** chirps with a long chirp is hearing and the LED start to flash then release the valet switch. You are now in the Start feature 'I' programming mode.
3. Press and release the transmitter button 'A' corresponding to the feature 'A' you want to program.

Press Transmitter Button	One Chirp / LED one pulse <b>Factory Default Setting</b>	Two Chirps / LED two pulse	Three Chirps / LED three pulse	Four Chirps / LED four pulse
1	Gasoline Engine	Diesel Engine and 10 seconds warn-up timer	Diesel Engine and 15 seconds warn-up timer	Diesel Engine and 20 seconds warn-up timer
2	10 minutes run time	20 minutes run time	30 minutes run time	5 minutes run time
3	Factory alarm disarm with channel 3 on	Without this feature		
4 *	Constant parking light output	Flashing parking light output		
5  +	Press * - * button = Activate Remote Start.	Press  + * button = Activate Remote Start.	Press * button = Activate Remote Start.	
6  + *	The Vehicle without Turbo Mode (The system Can not be Lock / Unlock with the engine running.)	The Vehicle has aftermarket Turbo timer installed: The system Can be Lock / Unlock with the engine running.	Built-in Turbo Timer Control is Active: Press  and * buttons at the same time to control Engine running one minute.	Built-in Turbo Timer Control is Active: Press  and * buttons at the same time to control Engine running three minute.
7  + *	3 Hour Time start	2 Hour Time Start	<b>Five chirps</b> = Built-in Turbo Timer Control is Active / Press  and * buttons at the same time to control Engine running five minutes.	

**Exit:** Turn Ignition to 'ON' position, or leave it for 15 seconds. A 3 long chirps & 3 parking light flashes to confirm exit.

**SAFE START (Child safety mode)**



Factory defaults setting to press the \* button twice to start the vehicle.

Programming this feature to eliminate an accidental remote start, when kids enter this transmitter, it requires: The user presses the transmitter and \* buttons at the same time to start the vehicle.

**START FEATURE “II” PRORAMMING:**

1. Turn the Ignition 'switch 'ON/OFF' 3 TIMES and stay in OFF position.
2. Push the Valet switch 10 times and holding in on the 10<sup>th</sup> push until **five** chirps with a long chirp is hearing and the LED start to flash then release the valet switch. You are now in the Start feature 'II' programming mode.
3. Press and release the transmitter button 'A' corresponding to the feature 'A' you want to program.



Press Transmitter Button	One Chirp / LED one pulse <b>Factory Default Setting</b>	Two Chirps / LED two pulse	Three Chirps / LED three pulse	Four Chirps / LED four pulse
1	Exit the programming mode. (3 long chirp & 3 parking light flashes to confirm this exit.)			
2  +	Engine Checking TACH.	Engine Checking Voltage	Engine Checking OFF	

3 	RPM learning			
	Start Timer: 0.6-second			0.8-second (2 chirps), 1.0-second (3 chirps), 1.2-second (4 chirps), 1.4-second (5 chirps), 1.6-second (6 chirps), 1.8-second (7 chirps), 2.0-second (8 chirps), 3.0-second (9 chirps), 4.0-second (10 chirps),
4 	Low check level for “Engine Checking TACH” mode or Hi check level for “Engine Checking Voltage” mode	Hi check level for “Engine Checking TACH” mode or Low check level for “Engine Checking Voltage” mode		
5 * - *	Start / Stop the system for TESTING & ADJUSTMENT			

**Exit:** Press the  button on the transmitter. A 3 long chirps & 3 parking light flashes to confirm exit.



### ENGINE CHECKING TACH. / RPM LEARNING

**Important Note:** You must program the “Tach Signal” before trying to remote start.

1. Turn the Ignition switch ‘ON/OFF’ 3 TIMES and stay in OFF position.
2. Push the Valet switch 10 times and hold it until five chirps with a long chirp is hearing and the LED start to flash then release the valet switch.
3. Press and release the transmitter  and  buttons at the same time once to set the “Engine Checking TACH.”. [1] LED flash, [1] chirp to confirm this setting.
4. Press and release the transmitter  button once, [1] LED flash, [1] chirp to indicate your are in features
5. Start the vehicle with the key. (While the engine is running, the parking light & LED will flash, If don't, please check tachometer White/Red wire connection. **(H6/5)**)
6. Press and hold the valet switch for 2 seconds until a long chirp and the LED / the parking light will constantly on for two seconds. The RPM signal is learned.
7. Turns off the ignition switch to stop engine running.



Once you complete step 7, you can adjust and test “Check Level” as below:

### CHECK LEVEL PROGRAMMING: (TEST and ADJUST)

1. Press the \* button twice on the transmitter to start the vehicle.
2. If everything goes well:
  - a. Press the \* button twice on the transmitter to stop engine running. You have been completed this programming successfully.
  - b. Press  button on the transmitter to exit the program mode. There will be 3 long chirps & 3 parking light flashes for confirmation.
3. If the crank time is too short, (The engine did not successfully run before the starter quit cranking):
  - a. Press the \* button on the transmitter to turn ignition lights “OFF”.  
Press  button on the transmitter to set proper “Check Level ” to Hi position. [2] LED flashes, [2] chirps to confirm this setting
  - b. Repeat the step1 – 4.
4. If the crank time is too long, (Engine is successfully running, while the starter is still cranking):
  - a. Press the \* button on the transmitter to stop engine running.  
Press  button on the transmitter to set proper “ Check Level ” to Low position. [1] LED flash, [1] chirp to confirm this setting
  - b. Repeat the step1 – 4.





### ENGINE CHECKING VOLTAGE

**Important Note:** The voltage “Check Level” for most vehicles would be set in “Hi Check Level”, while in “Engine Check Voltage” mode, the “Check Level” must be set at “HI” position first.



1. Turn the Ignition 'switch ‘ON/OFF’ 3 TIMES and stay in OFF position.
2. Push the Valet switch 10 times and holding in on the 10<sup>th</sup> push until five chirps with a long chirp is hearing then release the valet switch.
3. Press the transmitter  and  buttons at the same time to set the “Engine Checking Voltage”. [2] LED flashes, [2] chirps to confirm this setting.
4. Press  button on the transmitter to set “Check Level” to “HI” position. [2] LED flashes, [2] chirps to confirm this setting.

Once you complete step 4, you can adjust and test “Start Timer” as below:

### START TIMER PROGRAMMING: (TEST and ADJUST)



1. Press the \* button twice on the transmitter to start the vehicle.
2. If everything goes well, Wait for 15 seconds:
  - a. If the engine still running.
    - I. Press the \* button twice on the transmitter to stop engine running. You have been completed this programming successfully.
    - II. Press  button on the transmitter to exit the program mode. There will be 3 long chirps & 3 parking light flashes for confirmation.
  - b. If the engine shut down after the vehicle has been started.
    - I. Press the \* button twice on the transmitter to turn ignition lights "OFF".
    - II. Press  button on the transmitter to set "Check Level" to LOW position. [1] LED flash, [1] chirp to confirm this setting
    - III. Repeat the step1 – 2.
3. If the crank time is too long, (Engine is successfully running, while the starter is still cranking):
  - a. Press the \* button twice on the transmitter to stop engine running.
  - b. Press  button on the transmitter to set proper "Start Timer". The chirp & LED pause will confirm this enter. (Decrease "Start Timer" is necessary.)
  - c. Repeat the step1 – 4.
4. If the crank time is too short, (The engine did not successfully run before the starter quit cranking):
  - a. Press the \* button twice on the transmitter to turn ignition lights "OFF".
  - b. Press  button on the transmitter to set proper "Start Timer". The chirp & LED pause will confirm this enter. (Increase "Start Timer " is necessary.)
  - c. Repeat the step1 – 4.

### **ENGINE CHECKING OFF**

1. Turn the Ignition 'switch 'ON/OFF' 3 TIMES and stay in OFF position.
2. Push the Valet switch **10** times and holding in on the **10<sup>th</sup>** push until **five** chirps with a long chirp is hearing and the LED start to flash then release the valet switch.
3. Press the transmitter  and  buttons at the same time to set the "Engine Checking Off". [3] LED flash, [3] chirp to confirm this setting

Once you complete step 3, you can adjust and test "Start Timer" as below:



### **START TIMER PROGRAMMING: (TEST and ADJUST)**

1. Press the \* button twice on the transmitter to start the vehicle.
2. If everything goes well:
  - a. Press the \* button twice on the transmitter to stop engine running. You have been completed this programming successfully.
  - b. Press  button on the transmitter to exit the program mode. There will be 3 long chirps & 3 parking light flashes for confirmation.
3. If the crank time is too long, (Engine is successfully running, while the starter is still cranking):
  - a. Press the \* button twice on the transmitter to stop engine running.
  - b. Press the  button on the transmitter to set proper "Start Timer". The chirp & LED pause will confirm this enter. (Decrease "Start Timer" is necessary.)
  - c. Repeat the step1 – 4.
4. If the crank time is too short, (The engine did not successfully run before the starter quit cranking):
  - a. Press the \* button twice on the transmitter to turn ignition lights "OFF"
  - b. Press  button on the transmitter to set proper "Start Timer". The chirp & LED pause will confirm this enter. (Increase "Start Timer " is necessary.)
  - c. Repeat the step1 – 4.



### **RETURN TO FACTORY DEFAULT SETTING:**

1. Turn the ignition ON then OFF 3 TIMES and stay in OFF position.
2. Push the Valet switch **12** times and holding in on the **12<sup>th</sup>** push until **Six** chirp with a long chirp is hearing and the LED start to flash then release the valet switch. You are now in the "Return To Factory Default Setting" programming mode.

### **ALARM FEATURE ALL RETURNS TO FACTORY DEFAULT SETTING:**

3. Press the transmitter  and  buttons at the same time for 5 seconds, there will be a confirmation six chirp with 3 long chirp and the LED turns On for 2 seconds to confirm the system "Alarm Feature I & II Programming all returns to factory default setting.

### **START FEATURE ALL RETURNS TO FACTORY DEFAULT SETTING:**

4. Press  button first, within 3 seconds press and hold the  and  buttons at the same time for 5 seconds, there will be a confirmation six chirp with 3 long chirp and the LED turns On for 2 seconds to confirm the system "Start Feature I & II Programming all returns to factory default setting.

## SHUTDOWN DIAGNOSTICS

The unit has the ability to report the cause of the last shutdown of the remote start system.

1. Turn the Ignition 'switch to 'ON position.
2. Press the  button on the transmitter.
3. The LED will now report the last system shutdown by flashing for one minute in the following grouped patterns:

LED Flashes	Shutdown Mode	
1	(-) Safety Shutdown input (Hood)or	<ol style="list-style-type: none"> <li>1. Close the hood.</li> <li>2. Check H6/4 White/ Black wire connection.</li> </ol>
	(+ ) Safety Shutdown input or	<ol style="list-style-type: none"> <li>3. Check H6/3 White/ Violet wire connection.</li> </ol>
	Neutral Safety Switch input fail	<ol style="list-style-type: none"> <li>4. Move the Enable Toggle Switch to "ON" position. (If installed.)</li> <li>5. Move the gear selector to "Park"/ "NEUTRAL" position.</li> <li>6. Check H6/2 Black/White wire connection.</li> </ol>
3	No RPM (Engine Checking TACH.) or	Check H6/5 White/Red wire connection
	Low Voltage. (Engine Checking Voltage.	Program the "Check Level" from "Hi Check Level" to "Low Check Level"
5	Over-rev	
6	System timed out	
7	Transmitter	
8	Tach. Signal has not been learned	Re-learning the RPM (Start Feature <b>II – 2 / 3</b> )

## TESTING YOUR INSTALLATION:

**Caution!!** The follow procedure must be performed after the installation of the Remote Start Device. It is the responsibility of the installing technician to complete these tests. Failure to test the unit in the following manner may result in personal injury, property damage, or both.

1. Test the BRAKE shutdown circuit: With the vehicle in park (P), start the vehicle using the remote transmitter, Once the engine is running, press the brake pedal. The vehicle should shut down immediately. If the vehicle continues to run, check the brake circuit WHITE/ VIOLET wire (H6/3) connection.
2. Test the HOOD PIN shutdown circuit: Start the vehicle using the remote transmitter, Once the engine is running, pull the hood release and raise the hood. The vehicle should shut down immediately. If the vehicle continues to run, check the hood pin WHITE/ BLACK wire (H6/4) connection.

### 3. NEUTRAL START SAFETY TEST:

1. Set the vehicle parking brake.
2. Block the drive wheels to prevent vehicle movement.
3. Sitting in the vehicle, turn the ignition switch to "ON" or "RUN" position. But do not start the engine.
4. Step on the brake pedal and shift the gear selector into "DRIVE" (D).
5. Put your foot over the brake pedal but do not press down on it. Be ready to step on the brake to shut down the Remote Start Device.
6. Start the vehicle using remote transmitter.
  - a. If the starter does not engage, the test is complete.
  - b. If the starter engages, immediately step on the brake pedal to shut down the system, recheck your VIOLET wire (H1/1 starter output wire) connection. The heavy gauge VIOLET wire must be connected to the ignition switch side of the Neutral Start Switch. If the vehicle you are working on does not have an Electrical Neutral Safety Switch, it will be necessary to reconfigure the Remote Starts Wiring to accommodate this vehicle. The information concerning the Mechanical Neutral Safety Switch provided below will help you to determine if the vehicle you are working on has this type of safety switch and will provide alternate wiring methods to accommodate this situation.

### MECHANICAL NEUTRAL SAFETY SWITCH CONSIDERATIONS:

Mechanical neutral safety switch configurations differ slightly in that they do not offer the same level of safety when installing a remote start device. Often when the ignition switch is turned off while the gear selector is in any position other than park or neutral, the mechanical function will not allow the key to be turned to the start position or be removed from the ignition cylinder. This configuration prevents mechanical operation while the vehicle is in gear but offers no consideration for electrical operation. Because of this potential problem, this



installation requires the additional connection of a safety wire from the remote start device to the vehicle PARK/NEUTRAL ECM input or the vehicle key in sensor. This connection will prevent remote start operation if the key is left in the ignition switch regardless of the gear selector position.

**PARK/NEUTRAL ECM INPUT:**

The Park/Neutral ECM input is the preferred method of installation. This not only maintains the integrity of the factory circuit, it is also the easiest to install, providing the vehicle you are working on has this ECM input.

The installation required for this application (shown below), indicates in the slight reconfiguration of the control switch wiring. Shown is a typical GM Park/Neutral ECM input circuit. To connect the Remote Start unit to the GM Park/Neutral ECM input:

1. Locate the Orange/Black reference wire in the "C2" connector found at the ECM in GM B Body vehicles or, locate the equivalent reference wire in the vehicle you are installing the Remote Start Unit in.
2. Connect the BLACK/WHITE Neutral Safety Switch wire (H6/2) to this reference wire.

NOTE: If the optional remote starts enable toggle switch is installed, connect the one side the enable switch to this reference wire and connect the other side of the enable switch to the BLACK/WHITE Neutral Safety Switch wire (H6/2) of the Remote Start unit.

The reference diagram below shows a typical GM B Body ECM reference wire and how it is to be connected to the Remote Start Unit.

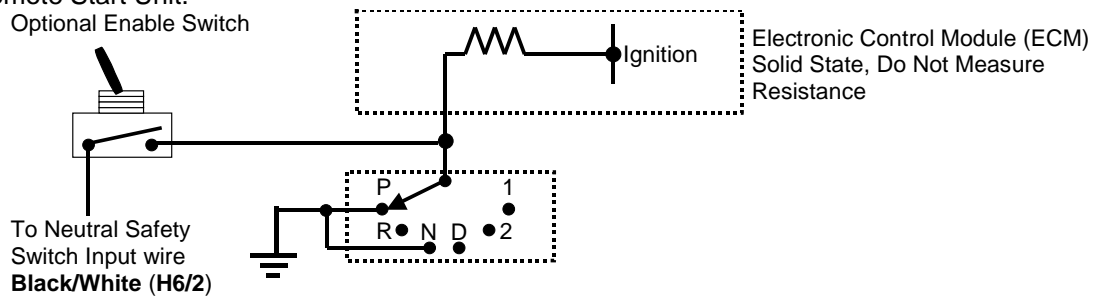

**KEY IN SENSOR CIRCUITS:**

If the vehicle you are working on does not have or you cannot locate the ECM reference wire, there are two alternatives available. Although not preferred, the vehicle Key In Sensor may be reconfigured to allow a margin of safety and will prevent the vehicle with a Mechanical Neutral Start Switch from starting in gear. WE ADVISES THAT YOU MAINTAIN THE FACTORY CIRCUIT WHENEVER POSSIBLE. The following two circuits may be used only if the above circuit is not available.

NOTE: When completing an installation using either of the following key in sensor circuits, if the operator inserts the ignition key while the vehicle is running under the control of the Remote Start, the vehicle will shut down. This must be explained to the operator as it is in contrast to the normal operation of a vehicle utilizing an electrical neutral start switch and is inconsistent with the operators manual.

Additional information concerning Key in Sensor methods 1&2 are listed below and should be reviewed before considering either alternative.

Method 1 will allow the safety required for the remote start unit and prevent the vehicle from starting while in any gear other than Park or Neutral while the key is in the ignition cylinder however, if the key is left in the ignition switch and the door is left opened, the added relay will be energized causing a 150mA drain on the battery.

Method 2 will allow the safety required for the remote start unit and prevent the vehicle from starting while in any gear other than Park or Neutral while the key is in the ignition cylinder however, the original factory key in chime module will not alert the owner that the key has been left in the ignition switch. In addition, this may also effect other warning tones such as the light on reminder.

These situations should be carefully considered before altering the vehicle's wiring and must be fully explained to the consumer.

**METHOD 1**

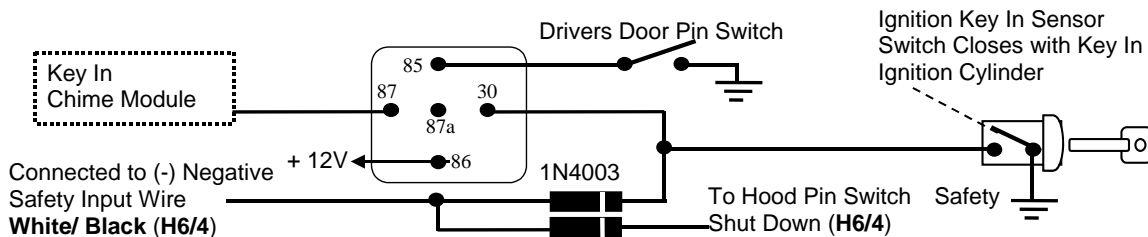

To connect to the key in sensor as shown in method 1:

- A. Locate the control wire that connects the drivers door pin switch to the key in sensor switch.
- B. Cut this wire and connect the ignition cylinder side to chassis ground.
- C. Locate the key in sensor switch wire that connects the chime module to the ignition cylinder.

- D. Cut this wire and connect the ignition cylinder side to terminal 30 of a P&B VF45F11 or equivalent relay.
  - E. Connect the cathode (striped) side of a 4003 series diode to this same wire, and connect the (non striped) side to the negative safety input wire (WHITE/ BLACK) (H6/4) of the Remote Start Unit.
  - F. Connect terminal 86 of the relay to a fused + 12 volt constant battery source.
  - G. Connect terminal 87 of the relay to the Chime Module side of the previously cut wire in step D.
  - H. Connect terminal 85 of the relay to the Drivers Door side of the pin switch wire previously cut in step B.
- Note:** A second 4003 series diode may be required to maintain the integrity of the hood open, shut down circuit. If this is the case, it must be installed as shown in the diagram above. The anode (Non Stripped) side must be connected to the WHITE/ BLACK wire (H6/4) of the Remote Start Unit. The cathode (Striped) side must be connected to the hood pin switch.

## METHOD 2

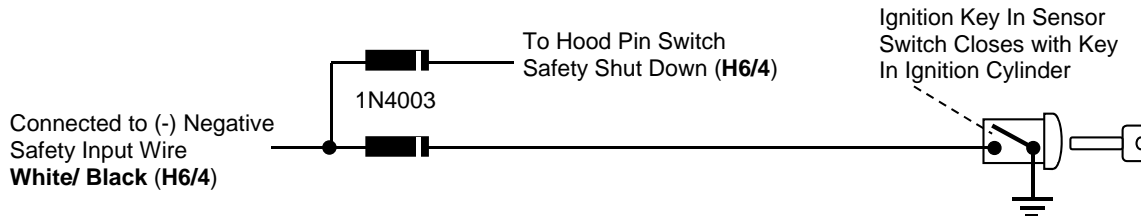

To connect to the key in sensor circuit as shown for method 2:

- A. Locate the control wire that connects the drivers door pin switch to the key in sensor switch.
- B. Cut this wire and connect the ignition cylinder side to chassis ground.
- C. Locate the key in sensor switch wire that connects the chime module to the ignition cylinder.
- D. Cut this wire and connect the ignition cylinder side to the Remote Start Negative Safety Shut down wire WHITE/ BLACK (H6/4), using a 4003 series diode as shown above.

**Note:** A second 4003 series diode may be required to maintain the integrity of the hood open, shut down circuit. If this is the case, it must be installed as shown in the diagram above. The anode (Non Striped) side must be connected to the WHITE/ BLACK wire (H6/4) of the Remote Start Unit. The cathode (Striped) side must be connected to the hood pin switch.

AFTER THE CONNECTION OF THE NEUTRAL START SAFETY WIRE AS INDICATED IN ANY OF THE PREVIOUS ALTERNATE CONFIGURATIONS, THIS CIRCUIT MUST BE TESTED FOR OPERATION.

Retest by following the steps outlined in the NEUTRAL START SAFETY TEST shown in this manual.



