

MEGALARM®

MEGA 3500

2-WAY LCD PAGER ALARM WITH
REMOTE ENGINE STARTER

Operation Manual



MEGATRONIX
VAN NUYS, CA U.S.A.

OPERATION:

A. REGULAR TRANSMITTER OPERATION:

Transmitter Button	System Function	Remark
	Lock Doors & Arm System	
	Arm and Noiseless mode	Press within 3 seconds.
	Arm and Delete The Zone 1 / Shock Sensor	Press twice within 3 seconds.
	Arm and Delete The Zone 4 / Optional Sensor	Press third time within 6 seconds.
	Arm and Delete The Zone 1 / Shock Sensor Delete The Zone 4 / Optional Sensor	Press fourth time within 6 seconds.
	Unlock Doors & Disarm System	
	Disarm & Channel 2 (Trunk) Timer Control	Press and Hold for 2 seconds
	Two Steps Door Unlock & Disarm System	Press twice within 3 seconds.
	Silent Arming / Disarming	Ignition in "off" position.
	Hidden Alarm Function	
	Activate Car-Jacking	Ignition in 'on' position and Press and Hold for two seconds
	Car Locator	
	Panic function	Press and Hold for 3 seconds
	Activate Remote Start	Press and Hold for 1 seconds
	System's Status Check	For TX-780V Only
	Channel 2 (Trunk) Timer Control	Press and Hold for 2 seconds
	Passive Arming By-pass	While the system Disarmed.
	Turn Off The Remote Start	
	Switching code For 2nd Car Operation or Garage Door Opener	For TX580S Only

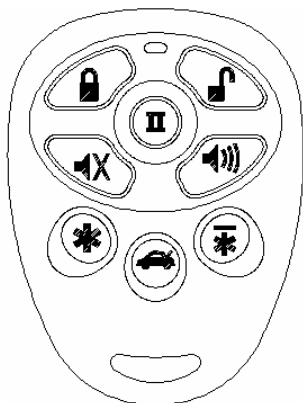

**TX580S
REGULAR
TRANSMITTER**

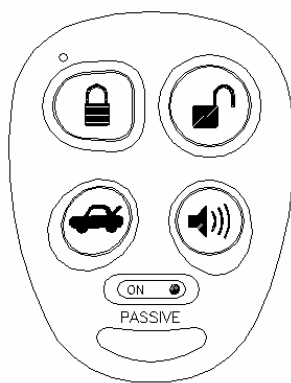

**TX040S
PASSIVE / ACTIVE
TRANSMITTER**

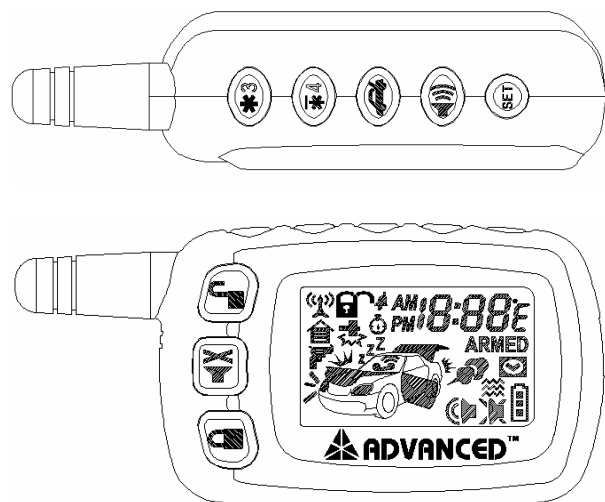

**TX-780V
TWO WAY COMMUNICATION
LCD SCREEN TRANSMITTER**

Second Vehicle Transmitter Programming: (Random code transmitter does not have this feature)

Your 8-button remote transmitter can be utilized to control a second vehicle security system, To program the remote control transmitter to a second vehicle, follow the instructions for Transmitter programming. All programming parameters be the same except for the following:

1. Prior to pushing any button on the transmitter. Press the Select the **II** button first.
2. Once the **II** button is pressed the LED on the transmitter will illuminate for 3.5 seconds.
3. While the LED is illuminated, press any button on the remote control transmitter.

B. UNIQUE OPTIONAL TX040S PASSIVE/ACTIVE TRANSMITTER

Turning the Passive System ON:

For total passive operation and conveniences, moving the passive transmitter's slider switch to "ON" position on the front case.

This will allow the system to auto arm as you exit and to auto disarm as you approach the vehicle.

The vehicle will remained disarmed and unlocked while you are moving around near the vehicle. After the passive disarm signals disappear the system will begin auto arming again etc. the vehicle will re-arm and re-lock the door 15 seconds after the last passive disarm signal was received.

In case the system armed and locks all doors, while you leave your ignition key and this transmitter inside the vehicle. Rock the vehicle the transmitter will disarm and unlock the doors.

AUTO DISARM

When you move toward your vehicle with the passive transmitter, the system will:

1. Automatically disarm the system.
2. Unlock the vehicle's door.

AUTO ARM:

When you move out of range with the passive transmitter, the system will:

1. Automatically arm the system after 15 seconds.
2. Lock the vehicle's door.

Note 1. Time delay:



- a. Upon the system is arm passively, the system will set a 15 seconds time delay for the passive feature, the passive feature will not work in 15 seconds.
- b. Upon you are active pressing the button on the transmitter to arm the system, the system will set a 60 seconds time delay for the passive feature, the passive feature will not work in 60 seconds.

Note 2. Turning the Passive System Off :

- a. You can disable the passive feature by moving the transmitter's slider switch to OFF. It will turn into normal active transmitter.
- b. If you are working around your vehicle and keeping your passive transmitter with you, you might want to turn the passive system off. If you don't, the transmitter will keeping locking and unlocking your doors.

TX040S PASSIVE/ACTIVE TRANSMITTER OPERATION:

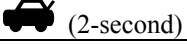
Transmitter Button	System Function	Remark
	Lock Doors & Arm System	
	Arm and Delete The Zone 1 / Shock Sensor	Press twice within 3 seconds.
	Arm and Delete The Zone 4 / Optional Sensor	Press third time within 6 seconds.
	Arm and Delete The Zone 1 / Shock Sensor Delete The Zone 4 / Optional Sensor	Press fourth time within 6 seconds.
	Unlock Doors & Disarm System	
	Disarm & Channel 2 (Trunk) Timer Control.	Press and Hold for 2 seconds
	Two Steps Door Unlock & Disarm System	Press twice.
	Silent Arming / Disarming	Ignition in "off" position.
	Activate Car-Jacking	Ignition in 'on' position and Press and Hold for 2 seconds
	Car Locator	
	Panic function	Press and Hold for 3 seconds
	Activate Remote Start	Press and Hold for 1 seconds

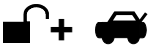
 (2-second)	Channel 2 (trunk) Timer control	Press and Hold for 2 seconds
	Passive Arming By-pass	While the System Disarmed.
	Turn Off The Remote Start	

C. LED display:

LED	Function
Off	Disarmed
Slow Flash	Armed
Flash	Passive Starter Disable
Fast Flash	Passive Arming
On (Solid)	Valet Mode
Pause On	Password Lock-Out

LED	Function
1 flashes... pause	Zone 1 / Trigger on-board Shock Sensor
2 flashes... pause	Zone 2 / Trigger on Trunk/Hood
3 flashes... pause	Zone 3 / Trigger on Door Switch
4 flashes... pause	Zone 4 / Trigger on Optional Sensor
5 flashes... pause	Zone 5 / Trigger on PIR or Door Sensor
6 flashes... pause	Zone 6 / Trigger on Ignition Switch

D. CHIRP INDICATORS:

Chirp	Function
1 chirp	Arm
2 chirps	Disarm
3 chirps	Defective Reminder
4 chirps	Disarm / Triggered
6 chirps	Car Locator

E. PARKING LIGHT:

Parking light	Function
1 flash	Arm
2 flashes	Disarm
3 flashes	Disarm / Triggered
12 flashes	Car Locator
Constant On	Under Remote Start

F. ALARM OPERATING CONDITION:

	Siren / Horn	Parking Light	LED	Doors	Starter	Dome Light
1. Arming	1 or 3 Chirps	1 Flash	Slow Flash	Locking	Disable	
2. Disarming	2 or 4 Chirps	2 or 3 Flashes	Fast Flash	Unlocking		Turns on for 30 -second
3. Trigger	Alarming	Flashes	Slow Flash		Disable	Flashes
4. Passive Starter Disable			Fast Flash		Disable	
5. Panic	Alarming	Flashes				Flashes
6. Car-Jacking	Alarming	Flashes			Disable	Flashes
7. Car Locator	6 Chirps	12 Flashes				

G. ACTIVE ARMING – LOCK & ARM:

1. Press  button on the transmitter.
 2. The siren will chirp once and parking light will flash once indicating that the system is now armed. The vehicle doors will lock upon arming when interfaced with the security system.
- Note: The wireless PIR sensor and wireless door/window sensor is delay trigger, it will arm after 30 seconds.

System Arm

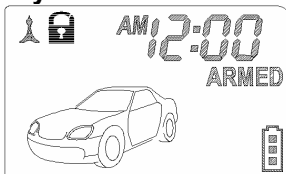

Door Ajar

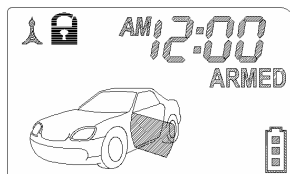

Trunk / Hood Ajar

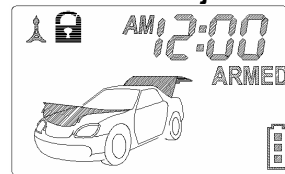

DEFECTIVE SENSOR REMINDER: If the siren sounds 3 chirps, then you have left a door, trunk, or hood lid ajar. (See Feature “I - 4 Programming)

SILENT ARMING / DISARMING: Press the  button on the transmitter will arm or disarm your security system, No chirp sound will be heard, arm / disarm confirmation will be through the vehicles parking lights only.

NOISELESS MODE: Press the  button once: The siren chirps once, The system is armed.

Press the  button within 3 seconds: The siren chirps once again, the system is now in Noiseless mode, On this mode trigger the zone 1 shock sensor or zone 4 optional sensor the trigger timer will reduced from 60 seconds to 15 seconds. .

The noiseless feature is programmed to activate for one arming cycle only. The security system will return to normal operation during the next arming cycle.

SHOCK SENSOR / OPTIONAL SENSOR BY-PASS:



Press the  button once: The siren chirps once, The system is armed.

Press the  button a second time within 3 seconds: The siren chirps once, the Zone 1 / Shock Sensor is now bypassed.

Press the  button a third time within 6 seconds: The siren chirps twice, the Zone 4 / Optional Sensor (connected to 4 pin plug) is now bypassed.

Press the  button a fourth time within 6 seconds: The siren chirps three times, the Zone 1 / Shock Sensor and the Zone 4 / Optional Sensor (connected to 4 pin plug) are now bypassed.

The sensor bypass feature is programmed to activate for one arming cycle only. The security system will return to normal operation during the next arming cycle.

HIDDEN ALARM FUNCTION: Press the  button first then press the  button within 3 seconds. The security system will arm and with "Hidden Alarm Function". The siren/horn will be silenced and parking light/dome light will not flash even if the sensors are triggered in the armed status.

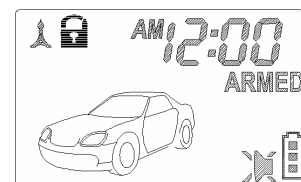

PASSIVE STARTER DISABLES: (see Alarm Feature I - 2 Programming)

The purpose of the feature is to protect the vehicle from being stole at all times, regardless of whether or not the alarm is armed.

The starter of the vehicle will be disable 60 seconds after the ignition is turned off. Once the key is turned off, the LED will flash fast for 60 seconds.

After 60-second timer has elapsed, the LED will flash slowly (one-half its normal armed rate) to indicate the passive starter disable is activated and the system will not respond to any trigger input except the ignition switch.

ARMING WHILE DRIVING: (see Alarm Feature I - 6 Programming)

You system can be armed while driving the vehicle! Simple press  button for 2 seconds while the vehicle is running, or the ignition is on. The system will chirp once and then once more to indicate the ignition is on. The system will not respond to any input except the door trigger and the starter kill relay and ignition disable relay will not be activated. The system will disarm automatically when the ignition is turned off. The siren will chirp twice and the LED will stop flashing.

H. PASSIVE ARMING



Active arming / disarming is controlling your security system via the remote transmitter. This security system is equipped with an optional Passive Arming feature, which allows the security system to arm 30 seconds after the last door is closed. Operation is as follows.

1. Turn the ignition to the "OFF" position and exit the vehicle.
2. After all entrances are closed, the security system LED will flash fast for 30 seconds. If you reopen any door / hood / trunk, the security system LED will stop flashing. It will begin flashing again once the vehicle all entrances are closed.
3. After 30-second timer has elapsed, the security system will automatically "ARM". The siren will chirp [1] time and the parking lights will flash [1] time.

PASSIVE ARMING WITH PASSIVE DOOR LOCKING (See Alarm Feature "I - 2" Programming):

The vehicle doors will automatically lock after passive arming cycle has been completed.

PASSIVE ARMING BY-PASS: While the system disarmed, Press the  buttons twice, the security will respond with [1] chirp and LED will turn "ON". The security system will remain in this temporally state

for as long as you wish. To exit passive by-pass, press the  or  button and the system will return to normal status.

I. ACTIVE DISARMING – UNLOCK & DISARM:

1. Press  button on the transmitter.

2. The siren will chirp twice and parking light will flash twice to indicating that the security system is now disarmed. The vehicle doors will unlock and dome light will turn on for 30 seconds upon disarming when interfaced with the security system.

System Disarm

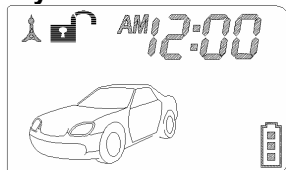

Doors Trigger

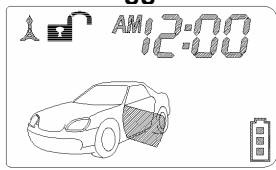

Trunk/Hood Trigger

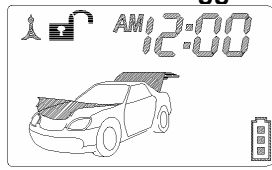

Shock Sensor Trigger

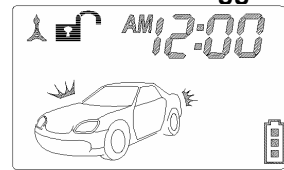

Optional Sensor Trigger

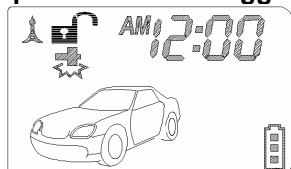

Ignition Trigger

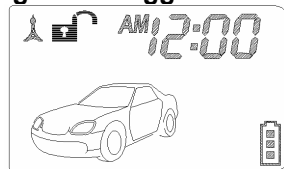

Activate PIR Sensor

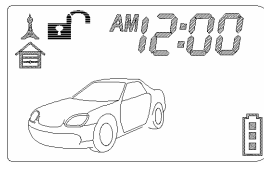

TAMPER DISARMING: If alarm triggered, upon disarm the system, siren chirp 4 times, parking light flash 3 times.

PATHWAY ILLUMINATION (See Alarm Feature "II - 4" Programming): This feature turns the parking light "ON" for 30 seconds upon a unlock signal and for 10 seconds upon the lock signal.

TWO STEPS DOOR UNLOCK (See Start Feature "I - 5" Programming): This feature will independently unlock the driver's door only when disarming the security system. Pushing the  button a second time within 3 seconds will unlock the entire vehicle.

AUTOMATIC RE-ARM (See Alarm Feature "I - 3" Programming): If this feature is selected, the security system will automatically re-arm itself 60 seconds after disarming with remote transmitter. Automatic rearm will cancel if any door is opened before the 60 seconds timer has elapsed.

J. DISARMING WITHOUT A TRANSMITTER

OVERRIDES THE ALARM WITHOUT PASSWORD PIN CODE: (Alarm Feature III - 4 Programming)

The Override function may be used if the remote transmitter is lost or inoperative.

1. Enter the vehicle and turn the ignition switch to 'ON' position. (Alarm will sound.)
2. Within 10 seconds push and release the valet switch

The alarm will stop sounding and enter the disarm mode. You can now start and operate the vehicle normally.

OVERRIDES THE ALARM WITH PASSWORD PIN CODE: (Alarm Feature III - 4 Programming)

Unlike valet switch easily found, and defeated, this security system allows the consumer to program a password pin code. Offering a higher level of security.

1. Enter the vehicle and turn the ignition switch to 'ON' position. (Alarm will sound.)
2. Within 5 seconds, enter your chosen first 10ths digit by press and release the Valet Switch.
(When finished above procedures, system's siren stop alarming, parking light stop flashing, other sensor stop trigger, but the vehicle can not be start and drive away.)
3. Within 15 seconds of the last entered 10ths digit, turn the Ignition Switch "OFF" then "ON".
4. Within 15 seconds, enter your chosen second 10ths digit by press and release the Valet Switch.
5. Turn the ignition switch "OFF" position.

[4] Chirps from siren/horn, [3] flash from parking light to indicate the system was disarmed.

Note 1: You must override the alarm within 60 seconds. If not, the system will automatically re-arm.

Note 2: If someone key-in at wrong password pin code, the system allows him to make 2 mistakes, if third time still wrong, it will automatically shut down for 5 minutes. During the period the system will not accept any correct number and the LED will "pause on" (the LED will turn on 1 second and turn off 0.1 seconds pause).

EXAMPLE: To Override The System With The Password Code 83, you would;

1. Enter the vehicle and turn the ignition switch to 'ON' position. (Alarm will sound.)
2. Within 5 seconds, Press and Release the Valet Switch 8 times
(When finished above procedures, system's siren stops alarming, parking light stop flashing, other sensor stop trigger, but the vehicle can not be start and drive away.)

3. Within 15 seconds of the last entered 10ths digit, turn the Ignition Switch "Off" then "ON".
 4. Within 15 seconds, Press and Release the Valet Switch 3 times
 5. Turn the Ignition Switch to "Off" position.
- [4] Chirps form siren/horn, [3] flash from parking light to indicate the system was disarmed.

K. VALET MODE: (System in Disarm or Valet mode)

The valet switch allows you to temporarily bypass all alarm function, eliminating the need to hand your transmitter to parking attendants or garage mechanics. When the system is in valet mode, all alarm function and remote start function are bypassed, however the remote panic feature and remote door locks will remain operational. To use the valet mode, the system must first be disarmed either by using you remote transmitter, or by operating the Manual override sequence.

Enter Valet Mode:

1. From the disarmed condition, turn the ignition to "ON" position.
2. Push and hold valet switch for 2 seconds until the LED turns on. The LED will remain on as long as the system is in 'valet mode'.

Remote Door Lock

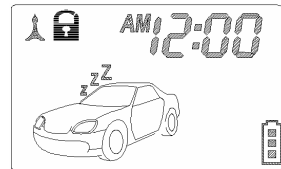

Remote Door Unlock

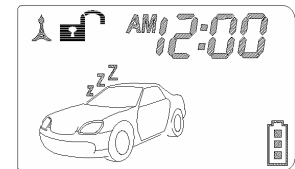

Exit Valet Mode:

1. Return to normal operation, turn ignition 'on'.
2. Push and hold valet switch for 2 seconds, The LED wills turns off indicate the system are exiting the valet mode.

L. CAR LOCATOR

Press the button to active car locator function. The siren will chirp 6 times. The parking light will flash 12 times, for you to easily locate your car.

M. PANIC FUNCTION: (See Alarm Feature I – 7 Programming)

The transmitter can be used as a remote panic switch to manually trigger the alarm in case emergency.

1. Press and hold the button for 3 seconds. The alarm will immediately sound.
2. During panic mode, the normal function of this transmitter button will be suspended. The and buttons can be used to lock and unlock the doors (if the option is installed), however once the button is pressed, the vehicle's starter disable device, (where installed) will be enable allowing the vehicle to start.
3. To stop the alarm, press and hold the or or or button on the transmitter again for 3 seconds. Also if any transmitter button other than the or or or button is pressed and released, the panic mode will be turned off immediately.
4. If the button is not pressed, the alarm will automatically stop after 60 seconds.

N. TRIGGER THE SYSTEM

When armed, your vehicle is protected as follows:

1. Light impacts will trigger the warn-away signal. A [3] long chirp from siren/horn.
2. Heavy impacts / Doors open / Hood open / Trunk open / Turn on the ignition key / Activate PIR sensor / Activate door/window sensor will trigger the programmed sequence.

The starter disable relay (if installed) prevents the vehicle's starter from cranking. The siren, horn, parking lights, and dome light will turn on to alerting of an intrusion for 60 seconds. Then it will stop and automatic reset and re-arm. If the one of sensors or detectors still active, the alarm system will sound a maximum of 3 times of 60 seconds cycles.

Doors Trigger



Trunk/Hood Trigger



Shock Sensor Trigger

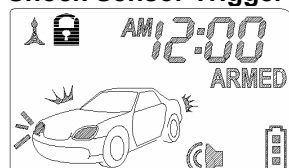

Optional Sensor Trigger



Ignition Trigger

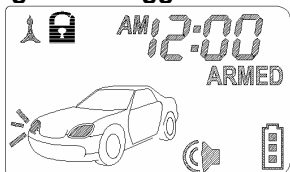

Activate PIR Sensor

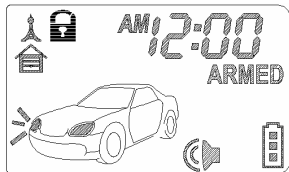

NOISE ABATEMENT CIRCUIT: Your system has “Noise Abatement Circuit”. It prevents annoying repetitive trigger sequences due to faulty door pin switches or environmental condition such as thunder, jackhammers airport noise, etc.

Here’s how “Noise Abatement Circuit” works: The alarm triggers five times. Each time, the same sensor or switch is triggering the alarm. “Noise Abatement Circuit” will interpret this pattern of triggers as false alarm. After the fifth trigger, “Noise Abatement Circuit” ignores, or bypasses, that sensor or switch until the other sensor or switch is triggered.

Doors (Hood/Trunk) are covered by “Noise Abatement Circuit” differently: If the alarm is triggered by an open door for six full cycles, the doors will be bypassed until the trigger ceases.

O. ANTI CAR-JACKING

Warning: If you don't need the car jacking function in this alarm system, be sure to set car jacking feature “OFF”. This system is default setting all car-jacking “OFF”. (See Alarm Feature I - 5 Programming.)

ACTIVE CAR JACK:

1. Press and hold  button on the transmitter for 2 seconds while the vehicle’s ignition is ON. The parking light will turns on for 1.5” seconds to indicate this enter.
2. Once the system is armed, If you are forced from the vehicle, the system will trigger when the door is opened and closed while the ignition is “ON”.

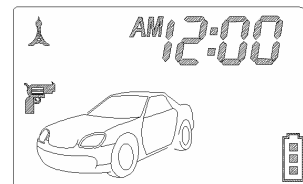

PASSIVE CAR JACK:

It operate as below:

1. Turn the ignition switch to “ON”, the system will arm.
2. Once the system is armed, If you are forced from the vehicle, the system will trigger when the door is opened and closed while the ignition is “ON”.

TRIGGER THE CAR JACK MODE:

3-timer circuits will function as follows:

First timer:

- a. 50 seconds after the system has beer triggered. The siren will start chirping for 15 seconds.
- b. During this 15 seconds period of chirping, you will be alerting to push the valet switch once to turn off the car-jacking feature.
- c. If not, it will enter second timer car jacking.

Second timer:

65 seconds after the system has beer triggered. The siren starts alarming and the parking light starts flashing.

Third timer:

90 seconds after the system has beer triggered

- a. The siren still alarming and the parking light flashing, and
- b. The starter disable will activate to prevent the vehicle from starting.
- c. It will remain active until the vehicle’s battery power exhausted.

OVERRIDE THE SYSTEM TO TURN OFF CAR JACKING:

Turn the ignition switch from OFF to ON, and within 10 seconds push valet switch, the siren will stop and the system disarmed

Note: If you use password pin code to double protect the vehicle security, you will need to use it to completely disarm the system.

P. DOME LIGHT CONVENIENCE DELAY & SUPERVISION

The alarm with a unique feature which will turn on your vehicle dome light as following:

1. Upon disarming, the interior lights will remain on for 30 seconds.
2. If the vehicle is intruded, the interior light will flash for the same duration as the siren.

Note: Turn on the ignition switch or arm the alarm will turn off the dome light.

Q. IGNITION CONTROL DOOR LOCKS. (See Alarm Feature **II – 2** Programming).

If the vehicles door locks have been interfaced to the security system, the system will automatically lock the vehicle's doors when the ignition is turned "ON" and /or unlock the vehicle's doors when the ignition is turned "OFF".

R. TRUNK RELEASE (CHANNEL 2) OUTPUT.

This will become a 1 second pulse ground by activate  button on the transmitter for two seconds. This feature allows you to remote control trunk release or other electric device. This output can also be programmed to provide the following type of output: momentary, latched, latched-reset with ignition, 30-second timed. (See Alarm Feature **II-6** Programming)

S. SYSTEM'S STATUS CHECK.

When you want to check the system's present status thru the LCD screen, Press the  button on "Two Way LCD Screen Transmitter", With one melody sound, the system's status will be shown on the LCD screen.

Note: Press **SET** for 2 seconds with 2 beeps confirmation to clear the trigger icons of LCD screen.

T. DRIVER PAGING (OPTIONAL)

1:The function works only in arming status as well as press  for 2 seconds.

It responds with chirps of the vehicle, melody sound and "call" indication flashes

on the LCD screen to confirm the function is on.

2: When tapping the paging (knock) sensor, one chirp sound shall be emitted from

the vehicle.

3. Any time while the system arms again, the function will be no more available.

If you installed the optional PAGING (KNOCK) SENSOR, it is useful the event that someone wants to page the driver of the parked vehicle.

If someone tries to page you by tapping the paging (knock) sensor which is usually mounted on the bottom part of front window, the paging melody sound continues sounding from you Remote LCD Transmitter and "call" indication flashes on the LCD screen.

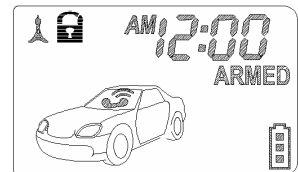
**U. POWER ON MEMONRY:**

This security system is equipped with circuitry that will allow the unit to remember its alarm state if the power is lost and then reconnected.

REMOTE START OPERATION:

WARNINGS:

As with any product that performs automatic functions, there are certain safety precautions that you must practice and be aware of.

1. Keep the transmitter out of children's reach.
2. Do not leave anyone in the vehicle while running on remote control.
3. Alert servicing personnel that the vehicle can be started automatically.
4. Do not start the vehicle by remote while it's in an enclosed area or garage.
5. Always apply the parking brake and lock the vehicle as you exit the vehicle.
6. Should the unit malfunction, disconnect the fuse until the problem is corrected.
7. The use and operations of this system is the sole responsibility of the operator.
8. Some areas may have local ordinances that prohibit leaving a vehicle running on public streets.

A. TO REMOTE START THE VEHICLE:

When you want to start your vehicle,

1. Press ***** button on the transmitter for 1 seconds.
2. The parking light will activate to indicate the remote start received the signal.
3. The engine will start approximately 5 seconds.
4. Once the engine is running, after couple seconds the parking light will turn on again and climate controls will activate and adjust the vehicles interior temperature to your preset setting.
5. The vehicle will run for 5 to 30 minute cycle and automatically shut down.

Activate Remote Start

Melody sound from
Two-way
LCD Transmitter

Engine is Running

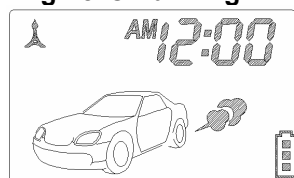

NOTE:

The Remote Start Unit will not start the vehicle if any one of the following conditions exists:

1. The hood is opened.
2. The brake pedal is pressed.
3. Move the optional remote start enable toggle switch to OFF position. (If installed)
4. The gear selector is in any gear other than "PARK" or "NEUTRAL"

B. TO TURN OFF THE REMOTE START:

When the engine is running (by remote start), if you want to stop it,

1. Press ***** button on the transmitter.
2. Move the optional remote start enable toggle switch to OFF position. (If installed)
3. Press the brake pedal

The vehicle will shut down and turn off the parking light to indicate engine stopped.

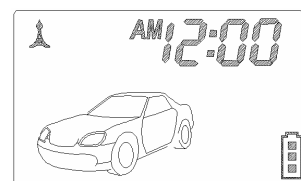

C. TO OPERATE THE VEHICLE WHILE RUNNING ON THE REMOTE START:

To operate the vehicle while running on the remote start.

1. Insert the ignition key and turn it to "ON" (not the start) position.
2. Press the brake pedal.

Note: If the brake pedal is pressed before the key is in the ON position, the engine will shut down.

D. TEMPORARY STOP FEATURE:

This feature allows the vehicle to remain running after the key has been removed from the ignition. This feature is useful for occasions when you wish to exit and lock the vehicle for short periods of time, but would like to leave the motor running and the climate control on.

1. Before turning off the engine, press the ***** button on the transmitter and the LED indicator will flash 3 times to confirm enter.
2. Turn the ignition key to OFF position. (The engine will stay running.)

3. The engine will run until the pre-programmed time elapsed or shutdown input is received.

E. TIMER / TEMPERATURE START:

This unit can be programmed to start and run the engine every 3 or 24 hours. The engine will run for the programmed run time and then shut down.



IMPORTANT: Timer Start should be used only in open areas, Never start and run the vehicle in an enclosed space as a garage or carport.

3 hours timer start with Temperature-control OFF: This feature is designed for an extreme cold climate usage. The system will auto start the vehicle every 3 hours, to prevent engine freezing and hard to start. A MAXIMUM OF SIX CYCLES CAN OCCUR.

3 hours timer start with Temperature-control: If you installed the optional Temperature Sensor and programmed the temperature ON to operate. The system can be programmed to automatically start the vehicle engine whenever the temperature inside the vehicle reaches or drops below the preprogrammed temperature level. The system will monitor the air temperature every 3 hours and will only start the engine during extreme cold temperatures. There are three temperature levels to choose from. (This feature is programmed OFF from the factory and must be programmed ON to operate. (See Start Feature I – 7 Programming))

24 hours timer start: This feature is designed for a battery charge usage. When the car owner has a long vacation, he can use this feature to auto start the vehicle and charge the battery every day, to prevent a low battery.

ENTER:

1. Press the * button to remote start the vehicle. As soon as the vehicle is running and the parking light have turned on or flashing.
2. Immediately depress the  button once, within 2 seconds.
- 4-a. 3 Hours auto start: Rapidly depress the * button once. The parking light will flash (3) times. The siren or horn chirps (3) times. The vehicle is now programmed to start every (3) hours.
- 4-b. 24 Hours auto start: Rapidly press and hold the  button once. The parking light will flash (12) times. The siren or horn chirps (12) times. The vehicle is now programmed to start every (24) hours
5. Press the brake pedal to stop the vehicle running.

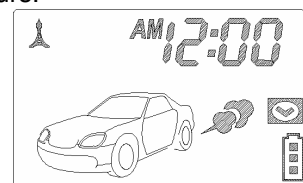

Exit the timer start:

Timer start can be exited manually as follows:

1. Make sure the remote start system is not operating the engine.
 2. Turn the ignition on. The LED and parking light will flash (4) times. The horn chirps (4) times.
- Or
1. Press the * button to remote start the vehicle. As soon as the vehicle is running and the parking light have turned on or flashing.
 2. Immediately depress the  button then press and hold the * button for 2 seconds. The parking light will flash (4) times. The siren or horn chirps (4) times. The vehicle is no longer programmed to start automatically.

F. TEMPERATURE CHECK (OPTIONAL)

If you installed the optional temperature sensor, you can monitor, thru the LCD screen, the present indoor temperature of the passenger compartment before cooling or heating your vehicle.

Press the  and * button at the same time on the “Two Way LCD Screen Transmitter”, the in-door temperature and system’s status will be shown on the LCD screen.

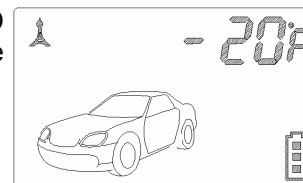

G. SHUT-DOWN INPUT FOR REMOTE STARTER:

If any of the following conditions exist while the system is operating, the engine will not start or will shut down immediately:

1. The hood is opened.
2. The brake pedal is pressed.
3. Engine is over-revved. {“Tachometer checking type” only}
4. The pre-programmed run time (5 / 10 / 20 / 30 minutes) has elapsed.
5. Transmitter  button is pressed.
6. Move the optional remote start enable toggle switch to OFF position. (If installed)

7. The vehicle refused to start running after {3} unsuccessful attempts.

H. DISABLING THE REMOTE START SYSTEM: (If installed)

This feature allows your system's remote start unit to be temporarily disabled to prevent the vehicle from being remote started accidentally. This feature is useful if the vehicle is being serviced or stored in an enclosed area. To disable the remote start, move the optional remote start enable toggle switch to the OFF position. (E)

LCD REMOTE TRANSMITTER:

Brief look of optional device

Two Way Remote Control

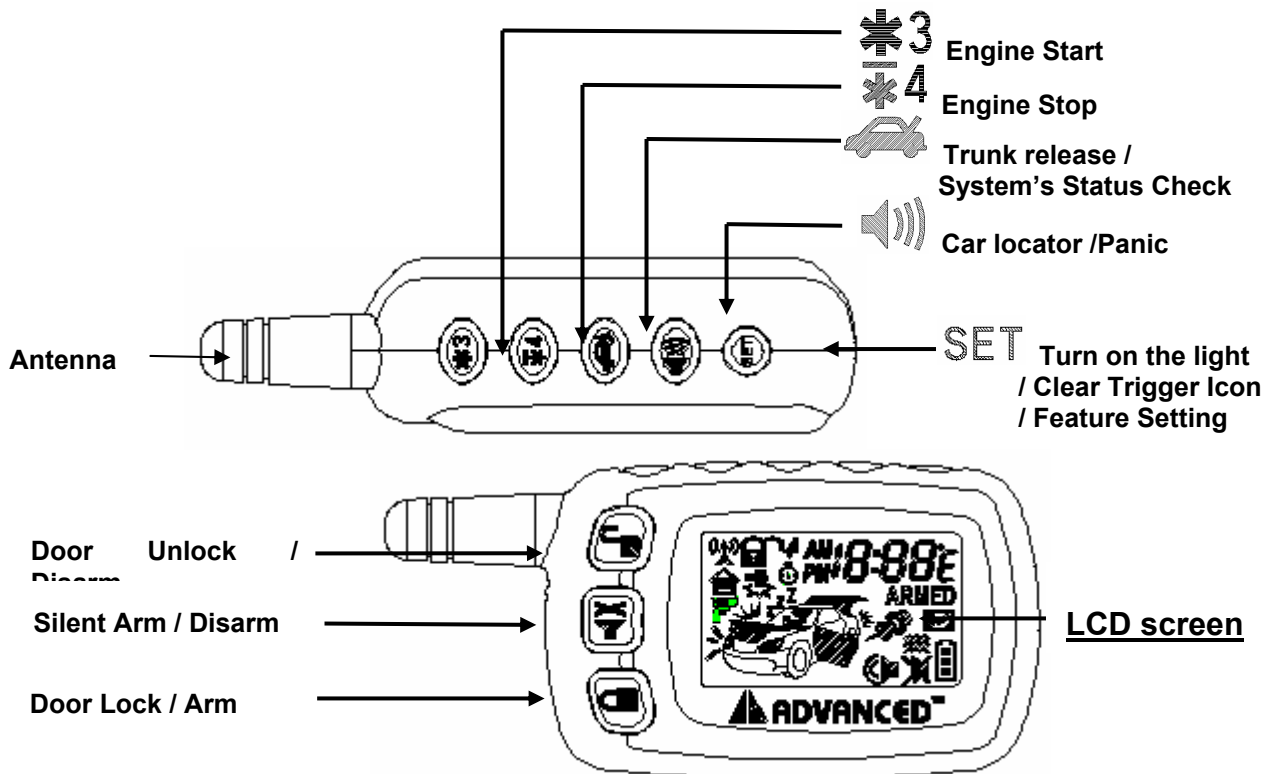

Two Way Transceiver/Antenna Module

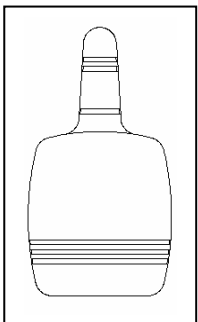

Paging Sensor (Optional)

It transmits and receives RF signals with the Remote Control. If you applied optional two-way LCD screen remote transmitter on your alarm system, you must install the new two-way transceiver /Antenna module on your control module.

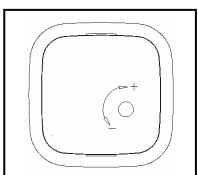

The device is usually mounted at the bottom part of the front window. In this device, there are paging(knock) sensor, which delivers the tapping impact to the Remote Control(for paging driver).

Temperature Sensor (Optional)

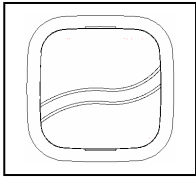

The temperature sensor which takes the temperature of the passenger compartment to display on the LCD screen of the Remote Control.

Battery replacement

A **1.5V type AAA Alkaline battery** powers the Remote Transmitter. When the power of the battery weakens

a  icon shall be displayed on the LCD screen. When the old battery is replaced to new one, there will be beep sounds indicate the power is up and the clock on the LCD screen returns to **AM12:00** after displaying all the icons.

Correct the time by pressing **SET** for 2 seconds before using (See Timer Setting).

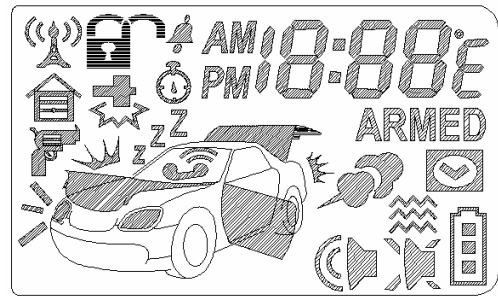
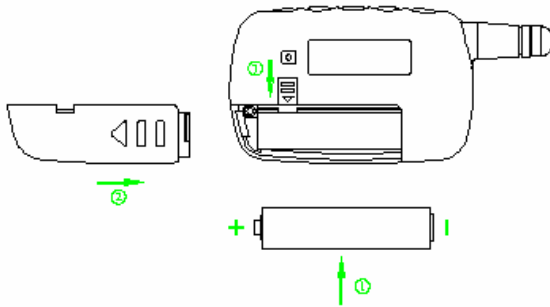

Door Lock

Your vehicle doors are locked



Door Unlock

Your vehicle doors are unlocked and the system is Disarmed



Armed Mode

Your vehicle is in armed mode



Valet Mode

All the function shall be temporarily on hold.



Remote Transmission

You are transmitting the signal to control unit

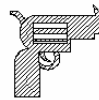

Anti-Carjacking Mode

Your vehicle is activated Anti-Carjacking



Door Open Warning

Doors are illegally opened (Zone 3)



Trunk/Hood Trigger

Trunk or Hood is illegally opened (Zone 2)



Optional Sensor Trigger

Trigger on Optional Sensor (Zone 4)



Shock Sensor Triggered

Trigger on board shock sensor (Zone 1)



Driver paging

Someone is paging you in front of your vehicle



Home Security trigger

Your PIR or Door Switch is triggered (Zone 5)

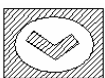

Timer Controlled Start

At the set time(3 hours or 24 hours), engine starts automatically



Flashing

Engine Start

Your vehicle's engine is running



Time Monitor

Time indicator of your vehicle



Alert Alarm

You have set morning call alarm



Count Down Timer

Reminder when time is up for parking



Temperature Monitor

Indoor temperature of your vehicle

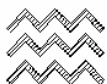

Vibration Mode

Remote Control vibrates when the system is triggered



Mute Chirp Sound

Operating silent when the icon is emitted



Low Battery

You have to replace the battery of remote control.

PROGRAMMING OF THE LCD REMOTE TRANSMITTER:

Transmitter Button	Description	Operation
SET	LCD screen lamp ON	Press once lamp on for 5 seconds
SET	Clear the trigger icon(s) on the LCD screen	Press & hold for 2 seconds
SET +	Set up fixed count down timer (10min./ 20min./ 30min./ 1Hr/ 1.5Hr/ 2Hr)	Press both button cycling *leave both buttons starting count down then flashes
SET +	Alert Alarm Setting(ON / OFF)	Press both button switching *Alarm On indicates on the screen
SET +	Set up Vibration / Melody Mode	Press both buttons switching *Vibration mode indicates . *Melody mode without but response melody

1. **SCREEN LAMP ON:** Press button SET once, the LCD screen lamp will Turns On for 5 seconds.

2. **CLEAR THE TRIGGER ICON(S):** Press SET once for 2 seconds then respond beep sound twice. It will clear the trigger icon(s) on the LCD screen.



3. SET UP FIXED COUNT DOWN TIMER:



1. Press button SET + once, the LCD screen will shows icon and timer (ie. 0:10) ,
2. Release the buttons start counting down.
3. Press both buttons simultaneously again showing next order time on the screen (ie.0:20), press them again (ie.0:30).....and so on.

Note: 1. The count down period is fixed as 10 minutes,20 minutes,30 minutes,1 hour, 1.5 hours and 2 hours maximum.
2. When count down timer showing 0:00 means to turn off the timer.



3. Press **SET** for real time indication when the timer is counting down.

4. ALERT ALARM SETTING (ON/OFF)



















Press button **SET** +  simultaneously, the LCD screen will show  icon and alarm time (ie 12:00) to turn on the alert alarm.

Press button **SET** +  simultaneously again, the  icon will disappear to turn off the alert alarm.

5. SET UP VIBRATION / MELODY MODE:





Press button **SET** +  4 simultaneously to select the mode of vibration or melody, the  icon will displayed on the LCD screen to show the LCD remote transmitter is on vibration mode.

TIMER SETTING:





Step	Transmitter SET Button	Description	Press Transmitter  or  Button
1	Press & Hold for 4 seconds	Time setting (Hour) *Flash digit for adjusting	 for - and  for +
2	Once	Time setting (Minute) *Flash digit for adjusting	 for - and  for +
3	Once	Alert Alarm Time Setting (Hour) *Flash digit for adjusting	 for - and  for +
4	Once	Alert Alarm Time Setting (Minute) *Flash digit for adjusting	 for - and  for +
5	Once	Alert Alarm Setting (On / Off)	 for Off and  for On
6	Once	Count down Timer Setting (Hour) *Flash digit for adjusting (Max.19 hours 59 minutes)	 for - and  for +
7	Once	Count down Timer Setting (Minute) *Flash digit for adjusting (Max.19 hours 59 minutes)	 for - and  for +
8	Once	Count down Timer ON/OFF	 for Off and  for On

EXIT: Press and hold the **SET** button for 4 seconds or leave it for 10seconds, the system will exit the programming mode.

1.TIME SETTING: Example to AM 10:30







- 1.Press **SET** once for 4 seconds then the hours digit flashes for adjusting.
- 2.Press  or  to decrease or increase the hour digit until AM10:xx
3. Press **SET** once again then the minutes digit flashes.
- 4..Press  or  to decrease or increase the minutes digit until AM 10:30

2. ALERT ALARM TIME SETTING: Example to PM 6:30

1. Press **SET** once for 4 seconds then the hours digit flashes.
2. Press **SET** twice then the alert alarm hours digit is flashing.
3. Press  or  to decrease or increase the hour digit until PM6:xx
4. Press **SET** once again then the minutes digit flashes.
5. Press  or  to decrease or increase the minutes digit until PM6:30
6. Press **SET** once again for alert alarm ON/OFF adjusting.

7. Press  for Off and  for On the alert alarm at PM6:30.

3. COUNT DOWN TIMER SETTING: Example set count down timer at 2:30

1. Press **SET** once for 4 seconds.
 2. Press **SET** 5 times then the hour digit flashes.
 3. Press  or  to decrease or increase the hours digit until 2:xx
 4. Press **SET** once again then the minutes digit flashes.
 5. Press  or  to decrease or increase the minutes digit until 2:30
 6. Press **SET** once again for count down timer ON/OFF adjusting.
 7. Press button  for Off and  for On of the count down timer at 2:30.
- Note:** Maximum is 19 hours 59 minutes.