

MEGALARM®

MEGA 680

DELUXE 4 CHANNEL ALARM SYSTEM

Installation And Operation Manual



MEGATRONIX
CHATSWORTH, CA U.S.A.

INSTALLATION DIAGRAM

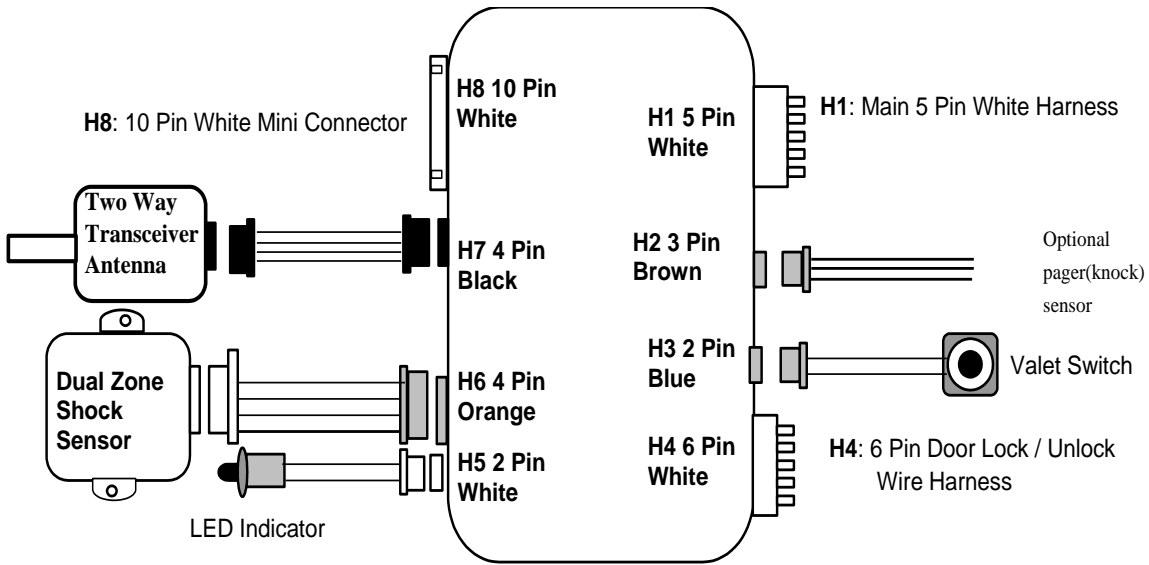

H1: MAIN 5 PIN WIRE HARNESS:

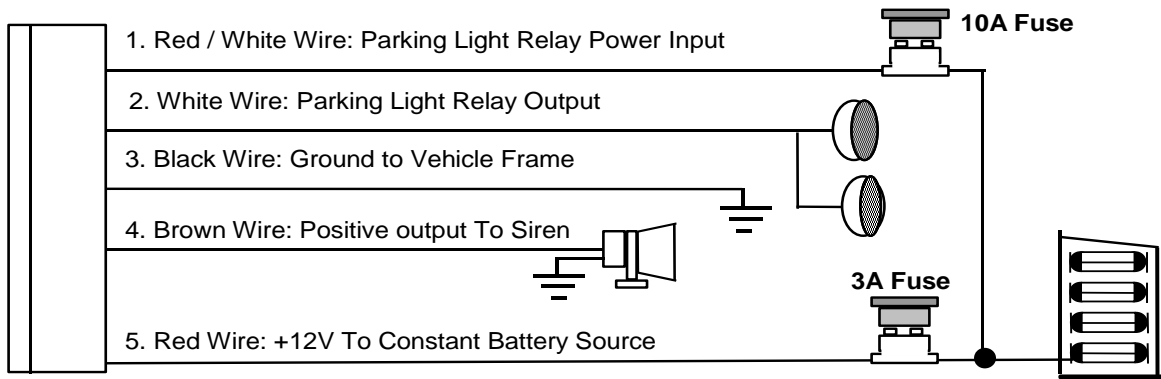

H8: 10 PIN MINI CONNECTOR WIRE HARNESS:

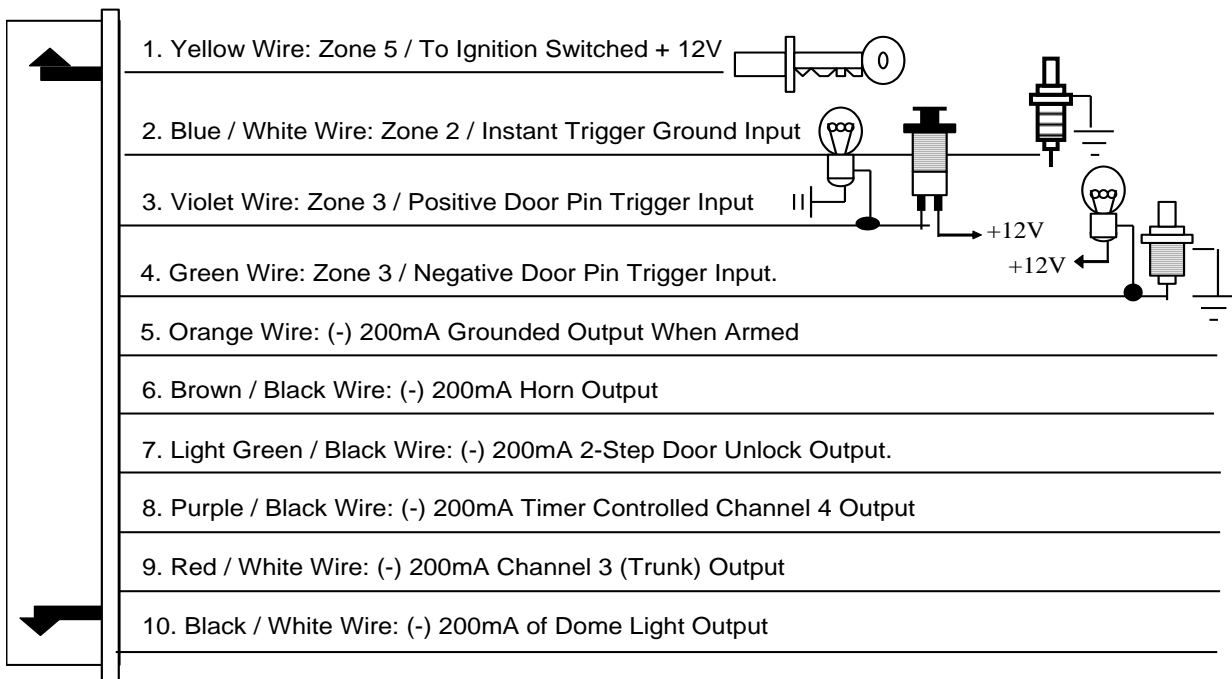

Keep wiring away from moving engine parts, exhaust pipes, and high-tension cable. Tape wires that pass through holes on the firewall to prevent frying electrical. Watch out for sharp edges that may damage wires and causes short circuit.

CAUTION: Do not connect the wire harness to the control module until all wiring to vehicle is complete.

H1. MAIN 5 PIN WIRE HARNESS:

H1/1. Red / White Wire – Parking Light Relay Input –

The RED/WHITE wire is the input to the flashing parking light relay. The connection of the RED/WHITE wire will determine the output polarity of the flashing parking light relay.

If the vehicle you are working on has +12volt switched parking light, you do not need to connect this wire. This wire already is connected to +12volt.

If the vehicles parking light is ground switched, cut the RED/WHITE wire and connect the RED/WHITE wire to chassis ground.

H1/2. White Wire – Parking Light Relay Output (+12 V 10A Output) –

Connect the WHITE wire to the parking light wire coming from the headlight switch. Do not connect the WHITE wire to the dashboard lighting dimmer switch (Damage to the dimmer will result). The limitation of the WHITE wire is 10 Amps max. Do not exceed this limit or damage to the alarm and parking light relay will result.

H1/3. Black Wire – System Ground –

This is main ground connection of the alarm module. Make this connection to a solid section of the vehicle frame. Do not connect this wire to any existing ground wires supplied by the factory wire loom. Make the connection to the vehicle's frame directly.

H1/4. Brown Wire – Siren Drive or Horn Output – (Set Feature III – 2 Programming)

SIREN DRIVE OUTPUT (Factory default setting)

This is the positive (+) output connection for the siren. Current capacity is 2 Amps. Make connection to the (+) red wire from the siren. Make the (-) black wire coming from the siren to a good chassis ground.

(+) Low Current HORN OUTPUT -- (Set Alarm Feature III – 2 To Horn Output)

This wire is provided to use the existing vehicle's horn as the alarm system's optional warning audible device. It is a transistorized low current output, and should only be connected to the low current positive (+) output from the vehicle's horn switch.

H1/5. Red wire – System Power (+12V Constant) –

The RED wire supplies power to the system. Connect this wire to a constant +12 volt source.

H2. 3-PIN BROWN CONNECTOR FOR OPTIONAL PAGING (KNOCK) SENSOR

An optional Paging (Knock) Sensor can be added on (For 2-Way Paging Systems Only).

1. Detach the protective paper from the double-sided adhesive tape and attach one side of the double-sided adhesive tape to the bottom part of the Paging (Knock) Sensor.
2. After cleaning the area around the left bottom part of the front windshield so that it stays attached firmly, the Paging Sensor should be attached on the front window so that the side on which a sticker with a printed words "Tap Here Paging Driver" is attached face outward.
3. Hide the wire by carefully pushing it inside the space of the front windshield's mold trim.

Adjust the sensitivity of the Paging Sensor. If you turn the tuning screw at the center of the Paging Sensor clockwise, the sensitivity goes sharp (higher) and if turned counter-clockwise, the sensitivity goes dull (lower).

H6. 4 PIN ORANGE CONNECTOR FOR 2 STAGE SHOCK SENSOR

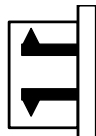

4. Green Wire / Warn Away Input
3. Blue Wire / Zone 4 Ground Trigger
2. Black Wire / Negative
1. Red Wire / +12Volts

H7. BLACK 4-PIN CONNECTOR. – TWO-WAY TRANSCEIVER/ANTENNA MODULE

The Two-way transceiver/antenna mounts on the location above the belt line (dashboard) of the vehicle for best reception. We suggest you mount it on the lower left or upper left-hand side of the windshield.

Warning! Do not mount in such a manner that it obstructs the driver's visibility.

- Remove the protective tape backing.
- Carefully align the two-way transceiver/antenna and apply to windshield.
- Route the black connector wire behind the trim and connect to the two-way transceiver/antenna.
- Connect the other end to the control module.
- Special considerations must be made for type of windshield glass, as some newer vehicles utilize a metallically shielded or infrared and UV radiation absorbing window glass that will inhibit or restrict RF reception. In these vehicles, route the two ways transceiver/antenna module away from metallic shielded window glass as far as possible. There might be an area of the windshield that does not have protection.

H8. 10-PIN MINI CONNECTOR WIRE HARNESS.

H8/1. Yellow wire – To Ignition Switched +12V –

This wire is connected to a switched 12 volts source. This wire should receive "12 volts" when the ignition key is in the "ON" and "START" position. When the ignition is turned "OFF", this wire should receive "0" voltage.

H8/2. Blue / White wire – (-) Instant Trigger or Major trigger Input (Zone 2) –

This wire is the ground trigger input wire for hood/trunk pin switches.

H8/3. Violet wire – Positive Door Switch Sensing Input –

This wire is the positive trigger input wire for positive door pin switch. This wire is the connection for "positive" type factory door pins (typical of Ford vehicles). Locate the "common wire" for all door pins and make the connection of the Violet Wire here.

H8/4. Green wire – Negative Door Switch Sensing Input –

This wire is the ground trigger input wire for negative door pin switch. This wire is the connection for "grounding" type factory door pins. Locate the "common wire" that connects the door pin switches. Make the connection of the GREEN Wire here.

H8/5. Orange wire – (-) 200mA Grounded Output When Armed –

This wire will become grounded when the alarm is armed. The current capacity of this wire is 200mA. This output can control the starter disable, when an intrusion is detected and the system is triggered. The vehicle is prevented from any unauthorized starting.

- Find the wire from the starter solenoid, (usually located on the starter) and going to the ignition switch.
 - When found, use voltmeter, connect one probe of the voltmeter to ground and connect the other end of the probe to the starter wire. It should receive "12 volts" only when the ignition key in the "START" position.
 - After locating the correct wire, cut it in half, try to start the vehicle. The engine should not "crank over".
 - If extended wires are needed, they must be exactly the same gauge as the cut wire. Connect the cut wire from the key switch to the RED wire (pin #30) of the relay, and connect the starter wire to the WHITE wire (pin #87a) of the relay.
 - Connect the ORANGE Wire from the control module to the ORANGE wire (pin #86) of the relay.
 - Connect the ORANGE wire (pin #85) of the relay to a switched 12 volts source from the ignition switch.
- NOTE: If more than one electronic device will be connected to the ORANGE Wire, it will be necessary to isolate the connection of each device control wires with a 1N4003 diode.

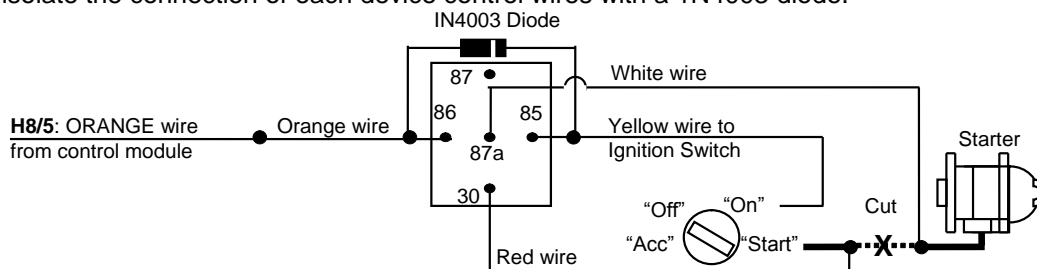



H8/6. Brown / Black wire – (-) 200mA Horn Output –

This wire is provided to use the existing vehicle's horn as the alarm system's optional warning audible device. It's a transistorized low current output, and should only be connected to the low current ground output from the vehicle's horn switch. When the system is triggered, the horn will sound.

H8/7. Light Green / Black wire – (-) 200mA 2-Step Door Unlock Output –

The 2-step door unlock feature will work for the most fully electronic door lock circuit. The vehicle must have an electronic door lock switch (not the lock knob or key switch), which locks and unlocks all of vehicle's doors. When wired for this feature, pressing the disarm (or unlock) button one time will disarm the alarm and unlock the driver's door only. If, you press the disarm (or unlock) button two times within 3 seconds, the alarm will disarm and all the doors will unlock.

H8/8 Purple / Black wire – (-) 200mA Channel 4 Programmable Output –

This wire is built-in user-programmable timer output provides a ground through this wire. Press the transmitter  and  buttons at the same time. You may program the built-in timer to send a ground signal for any time interval between 1 second and 2 minutes. For instance, this timer output may be used to turn on the headlight with the remote control. Also on certain BMW, Mercedes Benz, Jaguar and Volkswagen cars, you can use this unique timed output to allow remote closure of all power window and sunroof without the need for an external module!

H8/9. Red / White wire – (-) 200mA Channel 3 (Trunk) Output –

This will become a 1 second pulse ground by activating channel 3 on the transmitter for two seconds. The current capacity of this wire is 200mA. This feature allows you to remote control the trunk release or another electric device. This output can also be programmed to provide the following type of output: 1-second pulse, latched, timer control, and pager. (See Alarm Feature **III - 3** Programming

H8/10.Black / White wire – (-) 200mA Dome Light Control Output –

This wire becomes grounded when the dome light control circuit is active. The current capacity of this wire is 200mA. This wire can control the operation of the interior lights. An optional 10 Amp relay can be used on this system for interior lights operation.

- a). Upon disarming, the interior lights will remain on for 30 seconds.
- b). If the vehicle is violated, the interior lights will flash for the same duration as the siren.

H4. 6 PIN DOOR LOCK HARNESS:

	Blue/Red Wire: (87a) - Door Unlock Relay
	Blue/White Wire: (30) - Door Unlock Relay
	Blue/Yellow Wire: (87) - Door Unlock Relay
	Green/Red Wire: (87a) - Door Lock Relay
	Green/White Wire: (30) - Door Lock Relay
	Green/Yellow Wire: (87) - Door Lock Relay

INSTALL NEW DOOR LOCK MOTORS

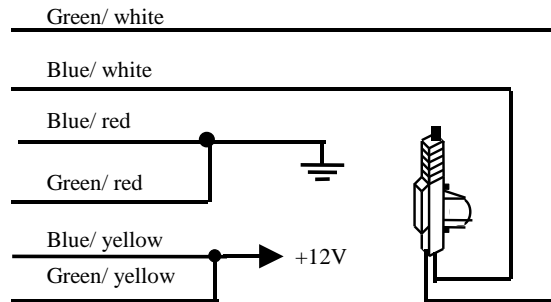

NEGATIVE TRIGGER DOOR LOCK SYSTEM

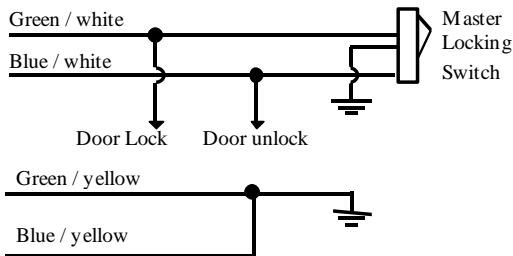

POSITIVE TRIGGER DOOR LOCK SYSTEM

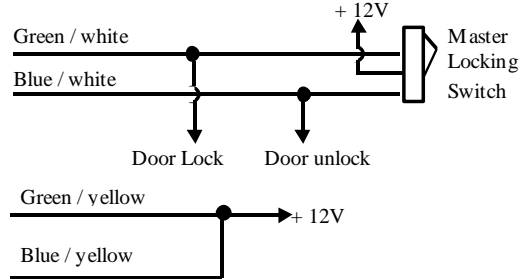

ALTERNATING DOOR LOCKS

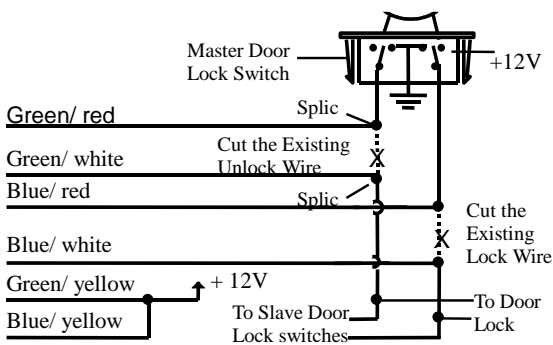

VACUUM OPERATE DOOR LOCKING SYSTEM

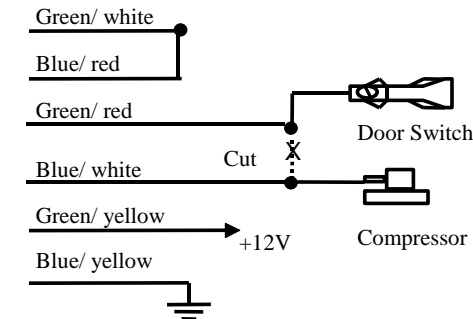

2 STEP DOOR UNLOCK WIRE CONNECTION FOR 5 WIRE ALTERNATING DOOR LOCKS

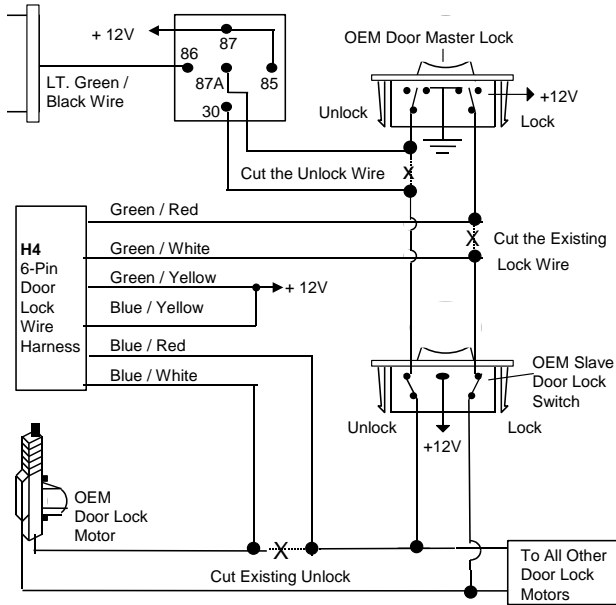

VACUUM OPERATED DOOR LOCKING SYSTEM:

TYPICAL OF MERCEDES BENZ AND AUDI.

Locate the wire under the driver's kick panel. Use the voltmeter connecting to ground, verify that you have the correct wire with the doors unlocked, the voltmeter will receive "12 volts". Lock the doors and the voltmeter will read "0 volt". Move the alligator clip to +12V and the voltmeter will receive "12 volts". Cut this wire and make connections. Be sure to program door lock timer to 3.5 seconds. (See Feature II – 1 Programming.)

2 STEP DOOR UNLOCK WIRE CONNECTION FOR GROUND SWITCHED DOOR LOCKS

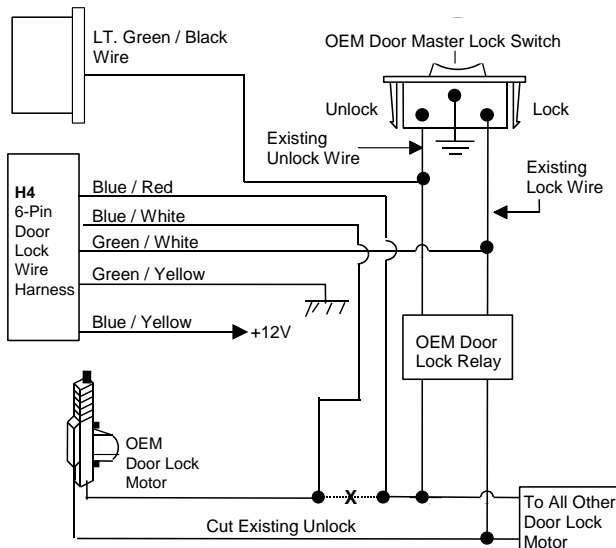

2 STEP DOOR UNLOCK WIRE CONNECTION FOR POSITIVE SWITCHED DOOR LOCKS

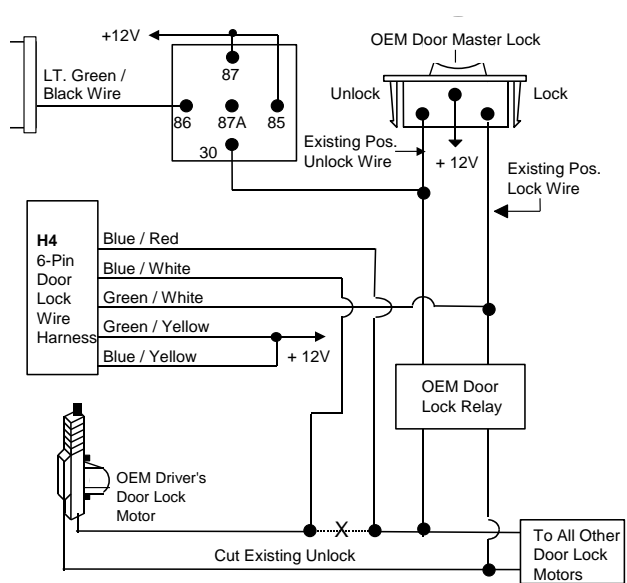

PROGRAMMING

A. THE TRANSMITTERS:

Note: This mode will only retain the last 4 remote transmitters programmed. If the transmitter memory is exceeded, the security system will start deleting transmitters from the memory in chronological order.





1. Turn the Ignition switch 'OFF/ON' 3 TIMES and stay in the ON position. Within 15 seconds.
2. Push the Valet switch **3** times and holding in on **3rd** push until a long chirp is heard. Then release the valet switch. You are now in the Transmitter programming mode.
3. Press and hold any button of the transmitter until the siren responds with a confirming chirp, indicating the signal has been stored into memory.
4. If you have additional transmitters (up to 4) that need to be programmed, repeat step 3 for each transmitter.

Exit: Turn Ignition to 'OFF' position, or leave it for 15 seconds. 3 long chirps & 3 parking light flashes will confirm transmitter programming exit.

B. ALARM FEATURES PROGRAMMING:

ALARM FEATURE "I" PROGRAMMING:



1. Turn the Ignition switch 'ON/OFF' 3 TIMES and stay in the OFF position.
2. Push the Valet switch **2** times and hold it on **2nd** push until **one** chirp with a long chirp is heard. Then release the valet switch. You are now in the Alarm feature 'I' programming mode.
3. Press and release the transmitter button 'A' corresponding to the feature 'A' you want to change.
 - a. The siren chirps and LED pause will indicate previously setting.
 - b. The system would advance to [2] LED flash, [2] chirp. (The factory default settings are always [1] LED flash, [1] chirp.)
4. Depress the transmitter button 'A' again to change the feature again. Simple keep re-depressing the transmitter button 'A' again until the module advances to your desired setting.
5. Depress the transmitter button 'B' corresponding to the feature 'B' you want to program.



Press Transmitter Button	One Chirp / One LED Pulse Factory Default Setting	Two Chirps / Two LED Pulses	Three Chirps / Three LED Pulses	Four Chirps / Four LED Pulses
1 	All Chirps off	All Chirps on	Siren Chirps on only	Horn Chirps on only
2 	Automatic Rearm off	Automatic Rearm on		
3 	45 seconds Delay Door Ajar error chirp.	Instantly Door Ajar error chirp		
4 * or 	Without Car-jack mode	Active Car-jack mode	Passive Car-jack mode	

Exit: Turn Ignition to the 'ON' position, or leave it for 15 seconds. 3 long chirps will confirm exit.

ALARM FEATURE "II" PROGRAMMING:

1. Turn the Ignition switch 'ON/OFF' 3 TIMES and stay in the OFF position.
2. Push the Valet switch **4** times and hold it on the **4th** push until **two** chirps with a long chirp is heard. Then release the valet switch. You are now in the Alarm feature 'II' programming mode.
3. Press and release the transmitter button 'A' corresponding to the feature 'A' you want to program.

Press Transmitter Button	One Chirp / One LED Pulse Factory Default Setting	Two Chirps / Two LED Pulses	Three Chirps / Three LED Pulses	Four Chirps / Four LED Pulses
1 	0.9-second door lock pulses.	3.5-second door lock pulse.	Double pulse unlock	Door lock with "Comfort Feature"
2 	Active arming	Passive arming without passive door locking	Passive arming with passive door locking	

3 	Ignition controlled door lock & unlock	Ignition controlled door lock only	Ignition controlled door unlock only	Without ignition controlled door lock & unlock
4 * or 	Pathway illumination feature "off"	Parking light "on" for 30 seconds upon an unlock signal	Parking light "on" for 30 seconds upon an unlock signal & 10 seconds upon a lock signal.	

Exit: Turn Ignition to the 'ON' position, or leave it for 15 seconds. 3 long chirps will confirm exit.





Comfort Feature:

Some Vehicles have a special "COMFORT feature". When you lock the door with the key, you just have to keep on turning the key on the door about 5 or 7 seconds and the window will close directly.

If your vehicle with "COMFORT feature" and you wish the door being locked and the window being closed automatically at the same time by remote control, you can set the alarm feature **II-1** "with comfort feature".



ALARM FEATURE "III" PRORAMMING:

1. Turn the Ignition switch 'ON/OFF' 3 TIMES and stay in the OFF position.
2. Push the Valet switch **6** times and hold it on the **6th** push until three chirps with a long chirp is heard. Then release the valet switch. You are now in the Alarm feature 'III' programming mode.
3. Press and release the transmitter button 'A' corresponding to the feature 'A' you want to program.

Press Transmitter Button	One Chirp / LED one pulse Factory Default Setting	Two Chirps / LED two pulses	Three Chirps / LED three pulses	Four Chirps / LED four pulses
1 	Vehicles without Turbo (The system cannot be armed with the engine running)	The vehicle has an aftermarket Turbo timer installed: The system can be armed with the engine running and: The shock sensor will be bypassed as long as the engine running.		
		The shock sensor will be bypassed for one minute	The shock sensor will be bypassed for one minute	The shock sensor will be bypassed for three minutes
2 	H1/4 Brown Wire = Constant siren output for six-tone siren	H1/4 Brown Wire = 5-second pulse siren output for single-tone siren	H1/4 Brown Wire = Random pulse siren output	H1/4 Brown Wire = Pulse output
3 	H7/7 Red / White Wire Channel 3 = 1 second pulse output for trunk release.	H7/7 Red / White Wire Channel 3 = Latch output	H7/7 Red / White Wire Channel 3 = Timer controlled output	
4 * or 	H7/10 Purple / Black Wire Channel 4 = Momentary output	H7/10 Purple / Black Wire Channel 4 = Latched output	H7/10 Purple / Black Wire Channel 4 = Latched output and reset with ignition "ON"	H7/10 Purple / Black Wire Channel 4 = Timer programming (set to any interval between 1 second and 2 minutes.)

Exit: Turn Ignition to the 'ON' position, or leave it for 15 seconds. 3 long chirps will confirm exit.

Channel 3 (4) Timer Control Output Programming

1. Turn the Ignition switch 'ON/OFF' 3 TIMES and stay in the OFF position.
2. Push the Valet switch **6** times and hold it on the **6th** push until **three** chirps with a long chirp is heard. Then release the valet switch. You are now in the Alarm feature 'III' programming mode.
- 3-a. Press and release the transmitter  button 3 times, [3] LED flash, [3] siren/horn chirp to indicate you are in features "Channel 3 Timer Programming mode".
- 3-b. Press and release the transmitter * or  button 4 times, [4] LED flash, [4] siren/horn chirp to indicate you are in features "Channel 4 Timer Programming mode".
4. Press and hold the valet switch, the timer will immediately start.

5. When the desired interval has passed, release the valet switch. 1 long chirp for confirmation.

(Set to any interval between 1 second and 2 minutes)

Note 1: If your built-in timer controls window/sunroof closure in your car, DO NOT change the timer setting! This requires installer-only programming. Changing the value will adversely effect operation and may cause damage.

Note 2:





Momentary output: The momentary output selection will output a negative signal from the Channel 4 output immediately when the Channel 4 button is pressed and will continue until the button is released.

Latched output: The latched output selection will output a negative signal as soon as the Channel 3 (4) button is pressed and will continue until the button is pressed again.

Latched output / reset with ignition: The latched / reset with ignition output selection operates just like the latched output but will reset or stop when the ignition is turned on.

ALARM FEATURE “IV” PRORAMMING:

1. Turn the Ignition switch 'ON/OFF' 3 TIMES and stay in the OFF position.
2. Push the Valet switch 8 times and hold it on the 8th push until four chirps with a long chirp is heard. Then release the valet switch. You are now in the Alarm feature 'IV' programming mode.
3. Press and release the transmitter button 'A' corresponding to the feature 'A' you want to program.

Press Transmitter Button	One Chirp / LED one pulse Factory Default Setting	Two Chirps / LED two pulses
1 	Exit the programming mode. (3 long chirps to confirm this exit.)	
2 	Override Without Password Pin Code / Press & hold  button for 4 seconds to delete the Password pin code	Override With Password Pin Code / Password pin code programming
3 	“TEST” Mode for Zone 2 Hood & Zone 3 Door Pin Switch	“TEST” Mode for Zone 4 / the Optional Sensor connected to 4-pin plug.

Exit: Turn Ignition to the 'ON' position, or leave it for 15 seconds. 3 long chirps will confirm exit.

Password Pin Code Setup:

1. Turn the Ignition 'switch 'ON/OFF' 3 times and stay in OFF position.
2. Push the Valet switch 8 times and hold it on the 8th push until **four** chirps with a long chirp is heard. Then release the valet switch. You are now in the Alarm feature 'IV' programming mode.
3. Press and release the transmitter  button once, [2] LED flash, [2] siren/horn chirp to indicate you are in features “Password Pin Code Programming mode”.
4. Within 15 seconds, begin to enter your chosen first 9ths digit by pressing and releasing the valet switch from 1 – 9 times.
5. Within 15 seconds of the last entered 10ths digit, turn the Ignition switch to the “ON” position.
6. Within 15 seconds, enter your chosen second 10ths digit by pressing and releasing the valet switch from 1 – 9 times.
7. Finish by turning the ignition switch to the “OFF” position.

If the new password code were accepted, the unit would report the newly entered code, by flashing the LED, first indicating the first digit code has been memorized, pause, and then the second digit code. The unit will report the new code three times with a one-second pause between each code.

Note: If 15 seconds of inactivity expire, or if the ignition switch is turned “ON” for more than 5 seconds during of the above steps, the unit will go back to the last successfully stored code. [3] long chirps will confirm password programming exit.

Delete Password Pin Code (Override Without Password Pin Code):

(Factory default setting)

1. Turn the Ignition switch 'ON/OFF' 3 times and stay in the OFF position.
2. Push the Valet switch 8 times and hold it on the 8th push until **four** chirps with a long chirp is heard. Then release the valet switch.
3. Within 15 seconds, press and hold the transmitter  button for 4 seconds. One long chirp to confirm that the Password Pin Code has been deleted.

Example: To program the Password Code 92, you would:

1. Turn the Ignition switch 'ON/OFF' 3 times and stay in the OFF position.

2. Push the Valet switch **8** times and hold it on the **8th** push until **four** chirps with a long chirp is heard. Then release the valet switch. You are now in the Alarm feature '**IV**' programming mode.
 3. Press and release the transmitter  button once, [2] LED flash, [2] siren/horn chirp to indicate you are in feature "Password pin code programming mode".
 4. Within 15 seconds, press and release the valet switch 9 times.
 5. Within 15 seconds of the last entered 10th digit, turn the Ignition Switch to "ON" position.
 6. Within 15 seconds press and release the valet switch 2 times.
 7. Turn the Ignition Switch to the "OFF" position.
- You will note the LED flashing nine times, pause and then flash two times, pause. This pattern will be repeated three times indicating the new code (92) has been accepted and stored in the memory.

Test Mode

In this test mode, this system can test the Zone 1 Warn Away Trigger / Zone 2 Instant ground trigger / Zone 3 Door trigger and the Zone 4 optional sensor sensitivity. The installer can save time to test the optional sensor sensitivity and sensor without using the traditional arming/disarming procedures to test the sensors.

Enter:

1. Turn the Ignition switch 'ON/OFF' 3 TIMES and stay in the OFF position.
2. Push the Valet switch **8** times and hold it on the **8th** push until **four** chirps with a long chirp is heard. Then release the valet switch. You are now in the Alarm feature '**IV**' programming mode.

3-a. Test the Zone 2 Instant Ground Trigger & Zone 3 Door Trigger:

Press and release the transmitter  button once. [1] LED flash, [1] siren/horn chirp to indicate you are in Zone 2 / instant ground trigger and Zone 3 / Door trigger test mode.



Trigger sensor	Siren chirps
Zone 2 / Instant Ground trigger (H7/2 Blue/White wire)	2
Zone 3 / Door trigger (H7/3 Violet & H7/5 Green Wire)	3

3-b. Test the Zone 1 / 2 Shock Sensor (Connected to H2 4 Pin Plug):

Press and release the transmitter  button again. [2] LED flash, [2] siren/horn chirps to indicate you are in shock sensor (connected to H2 4 pin plug) test mode.

1. Activate the warn-away (first stage optional sensor). The system will emit a short chirp.
2. Activate the full alarm (second stage optional sensor). The system will emit a long chirp.
3. Continue to test the optional sensor until you reach the proper sensitivity.

Return To Factory Default Setting:

1. Turn the ignition ON then OFF 3 TIMES and stay in the OFF position.
2. Push the Valet switch **12** times and hold it on the **12th** push until **six** chirps with a long chirp is heard. Then release the valet switch. You are now in the "Return to Factory Default Setting" programming mode.
3. Press the  and  buttons at the same time on the transmitter together for 5 seconds, there will be a confirmation six chirp with 3 long chirp to confirm the system Alarm Feature I & II & III & IV Programming all returns to factory default setting.

OPERATION:

TRANSMITTER OPERATION:

Transmitter Button	System Function	Remark
	Lock Doors and Arm System	
-	Arm and Delete 2 Stage Shock Sensor	Press twice within 3 seconds
- -	Arm and Noiseless Mode	Press within 3 seconds
-	Arm System and Hidden Alarm Function	Press within 3 seconds
+	Silent Arming / Disarming	Ignition in "off" position.
+ (2-second)	Active Anti Car-Jacking Mode	Ignition in "on" position press and hold for 2 seconds
	Unlock Doors and Disarm System	
-	2-Step Door Unlock and Disarm System	Press twice within 3 seconds
(2-second)	Trunk Release (Channel 3)	Press and Hold for 2 seconds
-	Passive Arming By-pass	While the system is disarmed
- -	Remote Control Entry/Exit Valet Mode	While the system is disarmed Press within 3 seconds
+	Channel # 4 Timer Output	
* or	Car Locator	
* or 3-second	Panic function	Press and Hold for 3 seconds

B.LED INDICATORS:

LED	Status
Off	Disarmed
Slow flash	Armed
Fast flash	Passive arming
On (solid)	Valet mode

LED	Status
2 flashes... pause	Zone 2 / Trigger on Trunk/Hood
3 flashes... pause	Zone 3 / Trigger on Door Switch
4 flashes... pause	Zone 4 / Trigger on Shock Sensor
5 flashes... pause	Zone 5 / Trigger on Ignition Switch

C. CHIRP INDICATORS:

Chirp	Function
1 chirp	Arm
2 chirps	Disarm
3 chirps	Ajar Warning
6 chirps	Car locator

D. PARKING LIGHT:

Parking light	Function
1 flash	Arm
2 flashes	Disarm
3 flashes	Triggered
12 flashes	Car locator



E. SYSTEM OPERATING CONDITION:

	Siren, Horn	Parking Light	LED	Doors	Starter	Dome Light
1. Arming	1 or 3 Chirps	1 Flash	Slow Flash	Locking	Disable	
2. Disarming	2 or 4 Chirps	2 or 3 Flashes	Fast Flash or Off	Unlocking		Turns on for 30 -second
3. Trigger	Alarming	Flashes	Slow Flash		Disable	Flashes
4. Panic	Alarming	Flashes				Flashes
5. Car-Jacking	Alarming	Flashes			Disable	Flashes
6. Car Locator	6 Chirps	12 Flashes				

F. ACTIVE ARMING – LOCK & ARM:

- Press button on the transmitter.
- The siren will chirp once and parking light will flash once indicating that the system is now armed. The vehicle doors will lock upon arming when interfaced with the security system.

AJAR WARNING: If the siren sounds 3 chirps, then you have left a door, trunk, or hood lid ajar. (See Alarm Feature "I - 3 Programming)



SILENT ARMING / DISARMING: Press the  and  buttons at the same time on the transmitter will arm or disarm your security system, No chirp sounds will be heard, arm / disarm confirmation will be through the vehicles parking lights only.

SHOCK SENSOR BY-PASS: Press the  button on the transmitter twice within 3 seconds will arm the security system and bypass the shock sensor. The system will chirp one additional time to confirm the sensor bypass mode was activated. The sensor bypass feature is programmed to activate for one arming cycle only. The security system will return to normal operation during the next arming cycle.

NOISELESS MODE: Press  button once. The siren chirps once, The system is now armed.

Press the  button twice more within 3 seconds: The siren chirps once again, the system is now in Noiseless mode. On this mode, for the zone 4 shock sensor, the trigger timer will reduced from 30 seconds to 15 seconds.

The noiseless feature is programmed to activate for one arming cycle only. The security system will return to normal operation during the next arming cycle.

HIDDEN ALARM FUNCTION: Press the  button first; within 3 seconds press the  button to activate the hidden alarm function. The security system will arm and with "Hidden Alarm Function". The siren / horn will be silenced even if the sensor is triggered in the armed status.



G. PASSIVE ARMING (See Feature "II - 2" Programming)

Active arming / disarming will allow you to control your security system via the remote transmitter. This security system is equipped with an optional Passive Arming feature, which allows the security system to arm 30 seconds after the last door is closed. Operation is as follows.

1. Turn the ignition to the "OFF" position and exit the vehicle.
2. After all entrances are closed, the security system LED will flash fast for 30 seconds. If you reopen any door / hood / trunk, the security system LED will stop flashing. It will begin flashing again once the vehicle all entrances are closed.
3. After 30-second timer has elapsed, the security system will automatically "ARM". The siren will chirp [1] time and the parking lights will flash [1] time and remain on for 10-seconds.

PASSIVE DOOR LOCKING: (See Feature "II - 2" Programming)

The vehicle doors will automatically lock after passive arming cycle has been completed.

PASSIVE ARMING BY-PASS: While the system disarmed, Press the  button twice, the security will respond with [1] chirp and LED will turn "ON". The security system will remain in this temporally state for as long as you wish. To exit passive by-pass, press the transmitter  or  button and the system will return to normal status.

H. ACTIVE DISARMING – UNLOCK & DISARM:

1. Press  button on the transmitter.
2. The siren will chirp twice and parking light will flash twice and then remain on for 30 seconds indicating that the security system is now disarmed. The vehicle doors will unlock and dome light will turn on for 30 seconds upon disarming when interfaced with the security system.

TAMPER DISARMING: If alarm triggered, upon disarm the system, siren chirp 4 times, parking light flash 3 times.

PATHWAY ILLUMINATION: (See Alarm Feature "II - 4" Programming): This feature turns the parking light "ON" for 30 seconds upon a unlock signal and for 10 seconds upon the lock signal.

TWO STEP DOOR UNLOCK: This feature independently unlocks driver's door only when disarming the system. Pushing the  button on the transmitter a second time within 3 seconds will unlock entire vehicle.

AUTOMATIC RE-ARM (See Feature "I - 2" Programming): If this feature is selected, the security system will automatically re-arm itself 60 seconds after disarming with remote transmitter. Automatic rearm will cancel if any door is opened before the 60 seconds timer has elapsed.

I. DISARMING WITHOUT A TRANSMITTER

OVERRIDE THE ALARM WITHOUT PASSWORD PIN CODE: (Factory Default Setting)

The Override function may be used if the remote transmitter is lost or inoperative.

1. Enter the vehicle and turn the ignition switch to 'ON' position. (Alarm will sound.)
2. Within 10 seconds push and release the valet switch.

The alarm will stop sounding and enter the disarm mode. You can now start and operate the vehicle normally.

OVERRIDE THE ALARM WITH PASSWORD PIN CODE: (Alarm Feature IV - 2 Programming)

Unlike valet switch easily found, and defeated, this security system allows the consumer to program a password pin code, offering a higher level of security.

1. Enter the vehicle and turn the ignition switch to the 'ON' position. (Alarm will sound.)
2. Within 5 seconds, enter your chosen first 10ths digit by pressing and releasing the valet switch.
3. Within 15 seconds of the last entered 10ths digit, turn the Ignition switch "OFF" then "ON".
4. Within 15 seconds, enter your chosen second 10ths digit by press and release the valet switch.
5. Turn the ignition switch "OFF" position.

[4] Chirps form siren/horn, [3] flash from parking light and LED will turn off to indicate the system was disarmed.

Note 1: You must override the alarm within 60 seconds. If not, the system will automatically re-arm.

EXAMPLE: To Override The System With The Password Code 83, you would;

1. Enter the vehicle and turn the ignition switch to 'ON' position. (Alarm will sound.)
 2. Within 5 seconds, press and release the valet switch 8 times
 3. Within 15 seconds of the last entered 10ths digit, turn the Ignition Switch "Off" then "ON".
 4. Within 15 seconds, press and release the valet switch 3 times
 5. Turn the Ignition Switch to "Off" position.
- [4] Chirps form siren/horn, [3] flash from parking light and LED will go off indicating system was disarmed.

J. VALET MODE: (System in Disarm or Valet mode)

The valet switch allows you to temporarily bypass all alarm functions, eliminating the need to hand your transmitter to parking attendants or garage mechanics. When the system is in valet mode, all alarm functions are bypassed, however the remote panic feature and remote door locks will remain operational. To use the valet mode, the system must first be disarmed either by using your remote transmitter, or by operating the Manual override sequence.

Enter Valet Mode:

1. From the disarmed condition, turn the ignition to the "ON" position.
2. Push and hold the valet switch for 2 seconds until the LED turns on. The LED will remain on as long as the system is in 'valet mode'.

Exit Valet Mode:

1. Return to normal operation, turn ignition 'on'.
 2. Push and hold valet switch for 2 seconds. LED will turn off indicating system has exited the valet mode.
- A parking flash to confirm enters valet mode and two parking lights flashing to confirm exit valet mode.

Remote Valet Mode:









1. Press and release  button on transmitter three times within 3 seconds to enter or exit valet mode.
2. One parking light flash will confirm you have entered 'valet mode' and two parking light flashes will confirm you exited 'valet mode'.

K. CAR LOCATOR

Press the * or  button to activate car locator function. The siren will chirp 6 times. The parking light will flash 12 times, for you to easily locate your car.

L. PANIC FUNCTION: (See Alarm Feature V – 4 Programming)

The transmitter can be used as a remote panic switch to manually trigger the alarm in case emergency.

1. Press and hold the * or  button for 3 second. The alarm will immediately sound.
2. During panic mode, the normal function of this transmitter button will be suspended. The  and  buttons can be used to lock and unlock the doors (if option is installed), however once the  button is pressed, the vehicle's starter disable device, (where installed) will be enable allowing the vehicle to start.
3. To stop the alarm, press and hold the * or  button on the transmitter again for 3 seconds. Also if any transmitter button other than * or  or  or  button is pressed and released, the panic mode will be turned off immediately.
4. If the button is not pressed, the alarm will automatically stop after 30 seconds.

M. TRIGGER THE SYSTEM

When armed, your vehicle is protected as follows:

1. Light impacts will trigger the warn-away signal.
2. Heavy impacts / Doors open / Hood open / Trunk open / Turning on the ignition key will trigger the programmed sequence.

The starter disable relay (if installed) prevents the vehicle's starter from cranking. The siren, horn, parking lights, and dome light will turn on to alert of an intrusion for 30 seconds. Then it will stop and automatic reset and re-arm. If the one of sensors or detectors is still active, the alarm system will sound a maximum of 6 times of 30 seconds cycles.

NOISE ABATEMENT CIRCUIT: Your system has "Noise Abatement Circuit". It prevents annoying repetitive trigger sequences due to faulty door pin switches or environmental condition such as thunder, jackhammers, airport noise, etc.



Here is how "Noise Abatement Circuit" works: The alarm triggers five times. Each time the same sensor or switch is triggering the alarm, the "Noise Abatement Circuit" will interpret this pattern of triggers or false alarms. After the fifth trigger, "Noise Abatement Circuit" ignores, or by pass, that sensor or switch until the other sensor or switch is trigger.

"Noise Abatement Circuit" covers doors, hood, and trunk differently: If the alarm is triggered by an open door for six full cycles (three minutes), the doors will be bypassed until the trigger ceases.

N. ANTI CAR-JACKING

Warning: If you do not need car jacking function in this system, be sure to set car-jacking feature "OFF". Default setting for this system is "OFF". (See Alarm Feature I – 4 Programming).

ACTIVE ANTI CAR JACKING:

1. Press and hold the transmitter  and  buttons at the same time for 2 seconds while vehicle's ignition is ON. The parking lights will turn on for 1.5 seconds to indicate the system enters the car-jacking mode.
2. Once the system in car-jacking mode, if you are forced from the vehicle, the system will be trigger when the door is opened and closed while the ignition is "ON".

PASSIVE ANTI CAR-JACKING:

1. Turn the ignition switch to "ON" position; the system enters the car-jacking mode.
2. Once the system in car-jacking mode, if you are forced from the vehicle, the system will trigger when the door is opened and closed while the ignition is "ON".

TRIGGER THE ANTI CAR-JACKING MODE:

- a). 50 seconds after the system has beer triggered. The siren will start chirping for 15 seconds.
- b). During this 15 seconds period of chirping, are being alerted to push the valet switch once to turn off the car-jacking feature. If not, it will enter the second timer car jacking.
- c). 65 seconds after system has been triggered, the siren starts alarming and parking lights start flashing.
- d). 90 seconds after the system has been triggered:
 1. The siren will continue alarming and the parking lights flashing, and
 2. The starter disable will activate to prevent the vehicle from starting.
 3. It will remain active until the vehicle's battery power is exhausted.

OVERRIDE THE SYSTEM TO TURN OFF ANTI CAR- JACKING:

Turn the ignition switch from OFF to ON, and within 10 seconds push valet switch, the siren will stop and the system disarmed

Note: If you use password pin code to double protect the vehicle security, you will need to use it to completely disarm the system.

O. DOME LIGHT CONVENIENCE DELAY & SUPERVISION

The alarm has a unique feature that will turn on your vehicle dome light as following:

1. Upon disarming, the interior lights will remain on for 30 seconds.
2. If the vehicle is intruded, the interior light will flash for the same duration as the siren.

Note: Turning ON the ignition switch or arming the alarm will turn off the dome light.

P. IGNITION CONTROL POWER DOOR LOCK SAFETY SYSTEM (See Feature II – 3 Programming.)



1. Turn the ignition switch on and close all the vehicle's doors. After 3 seconds, the system will automatically lock the central locking system.
2. Turn the ignition switch off. The system will automatically unlock the central locking system.

Q. TRUNK RELEASE (Factory default setting) / CHANNEL 3 TIMER CONTROL OUTPUT (See Alarm Feature III – 3 Programming.)

Press and hold  button on transmitter for 2 seconds to control trunk release or other electric devices. Channel 3 is user-programmable timer output. You may program the built-in timer to send a ground signal for any time interval between 1 second and 2 minutes. For instance, this timer output may be used to turn on the headlights, power windows, or sunroof.

Note: Factory default setting at 1-second pulse grounded for trunk release output.

R. CHANNEL 4 TIMER CONTROL OUTPUT (See Alarm Feature III- 4 Programming)

Press the transmitter  and  buttons at the same time to active Channel 4 function. Channel 4 is user-programmable timer output. You may program the built-in timer to send a ground signal for any time interval between 1 second and 2 minutes. For instance, this timer output may be used to turn on the headlight, power windows, or sunroof.

Note: Factory defaults setting at momentary output.

S. POWER ON MEMORY:

This security system is equipped with circuitry that will allow the unit to remember its alarm state if the power is lost and then reconnected.

T. 2-WAY UPGRADE:

This unit is capable of 2-way communication to notify the owner if anyone is trying to tamper with the vehicle or to confirm remote start operation. If you would like to upgrade this unit to a 2-way system, please contact: Megatronix (www.megatronixusa.com)

This device complies with part 15 of the FCC rules. Operation is subject to the following two conditions.

- (1) This device may not cause harmful interference, and
- (2) This device must accept any interference received, including interference that may cause undesired operation.