

# **VIKING™**

## **VS 2400**

### **DELUXE 4 CHANNEL ALARM WITH REMOTE ENGINE START**

Installation And Operation Manual



**MEGATRONIX**  
**CHATSWORTH, CA U.S.A.**

# INSTALLATION DIAGRAM

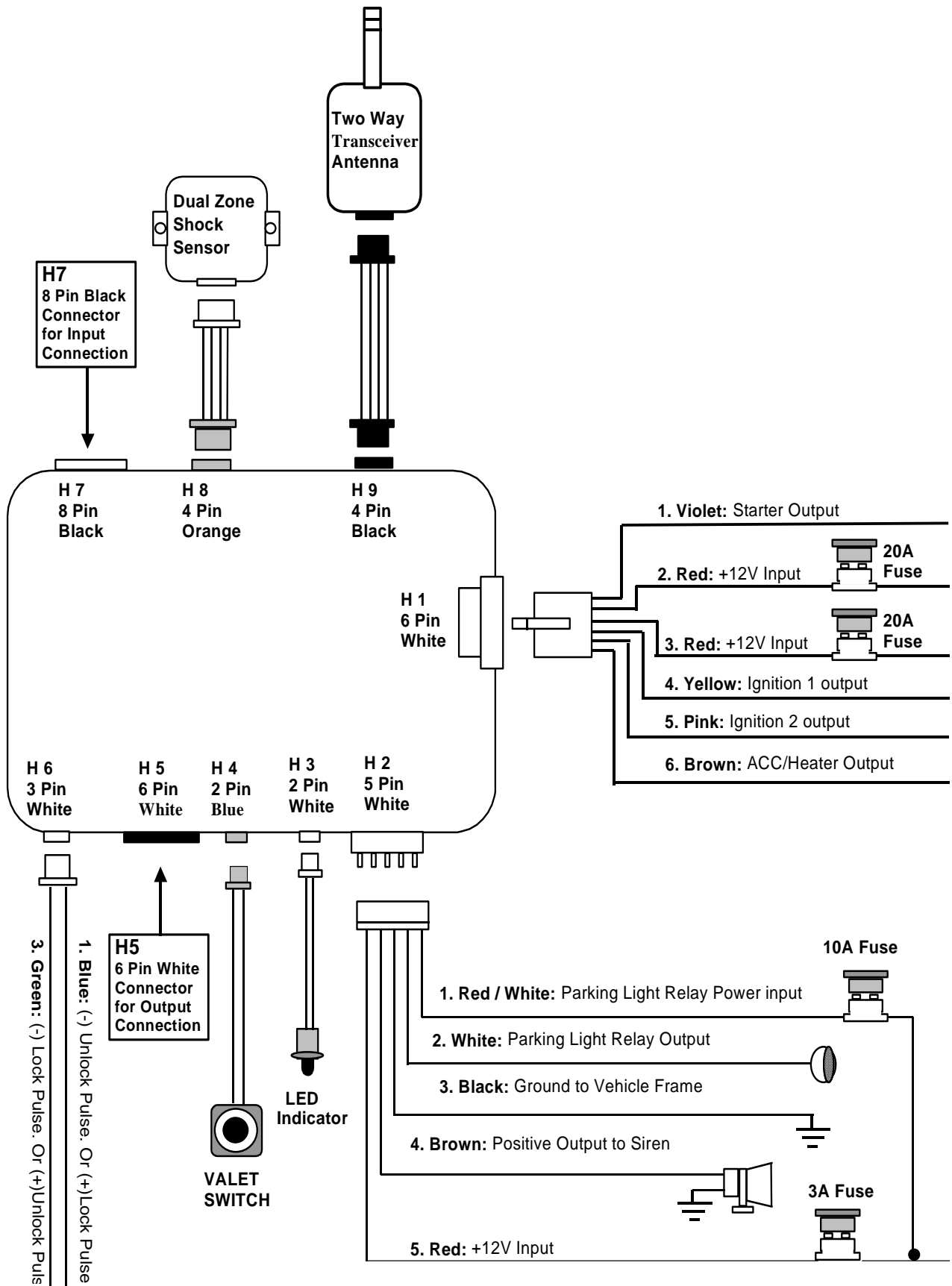

## #H5 6 PIN WHITE CONNECTOR FOR OUTPUT CONNECTION

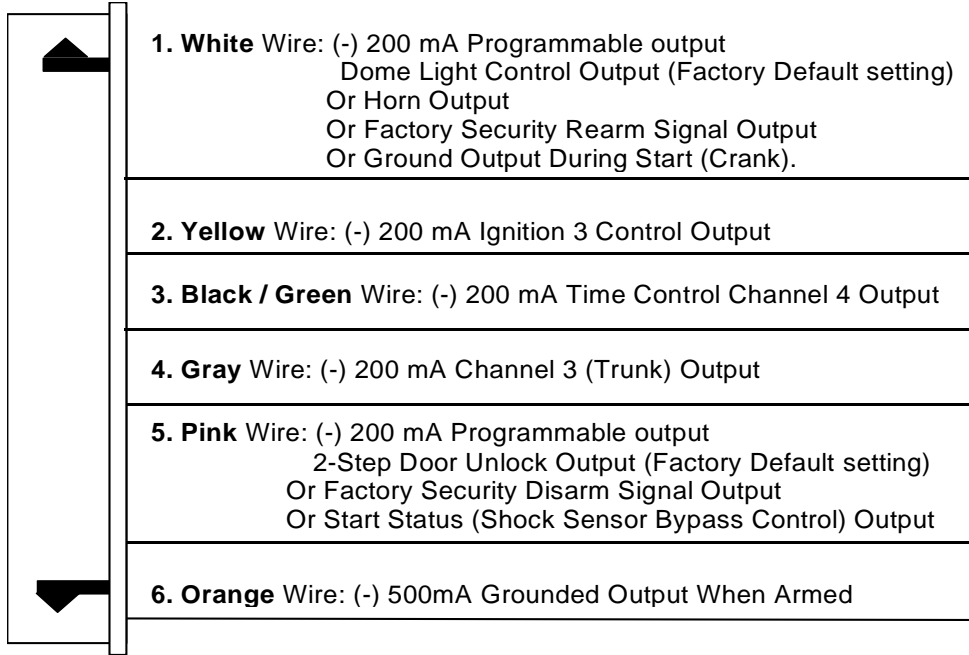

## #H7. 8 PIN BLACK CONNECTOR FOR INPUT CONNECTION:

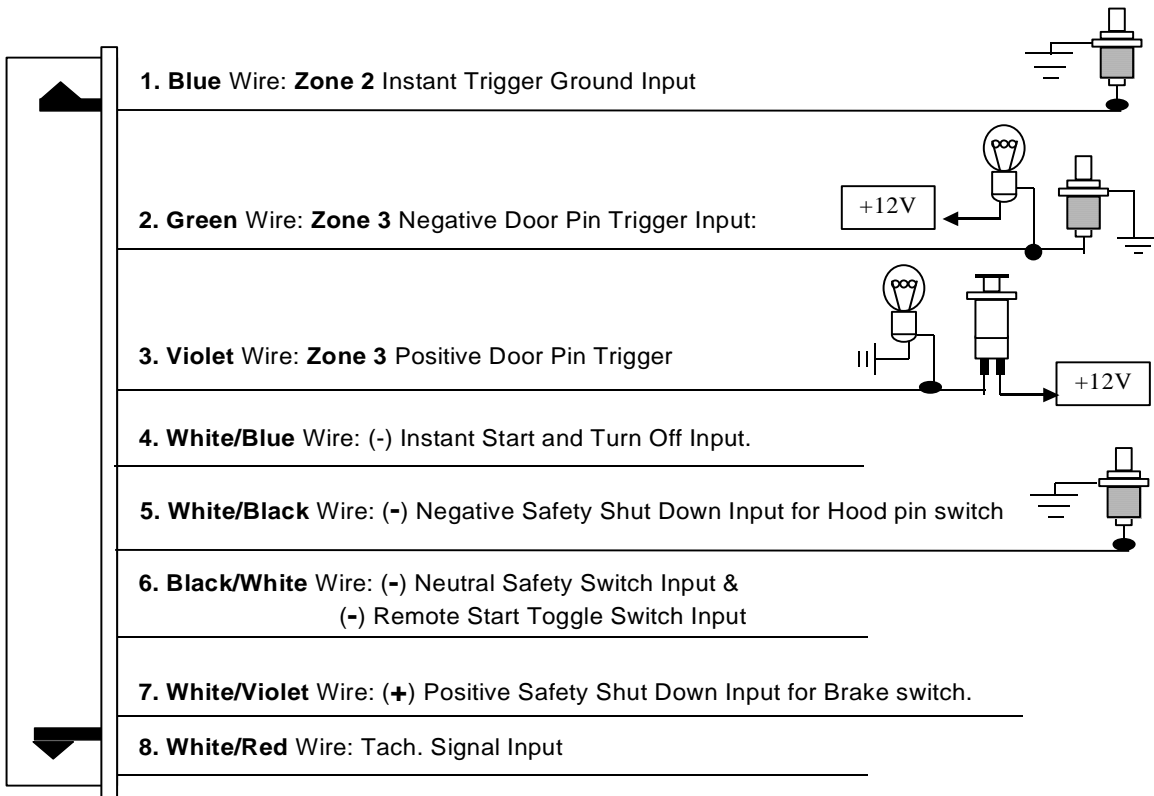

**IMPORTANT NOTE:** Directly connect the H7/6 BLACK/WHITE wire to the "GROUND" when this wire is not used.

## INTRODUCTION

### INSTALLER WARNINGS

This Remote Starter with Alarm System is designed to be installed on fuel injected vehicles ONLY.

- For automatic transmission vehicle, this system must be installed and wired through a safety switch it will not start in any forward or reverse gear.
- Some automatic transmission vehicle [mainly older GM vehicles with a purple starter wire] have a mechanical-type park safety switch instead of electrical safety switch. The mechanical type does not interrupt the starter circuit when the transmission is any gear and does not offer the 100% level of safety required for remote starting purposes. Therefore, our system should never be installed on any vehicle that uses a mechanical type park safety switch.
- For automatic transmission vehicle, once you install this system, you must verify that the vehicle will not start any forward or reverse gear. Regardless of the type of vehicle.
- Read operation manual for operating and programming routine.
- Do not install any component near the brake, gas pedal or steering linkage.
- Some vehicles have a factory installed transponder immobilizer system that can severely complicate the installation. There is possibility that this system can not be installed on some immobilizer equipped vehicles.
- Most vehicles have an SRS air bag system. Use extreme care and do not probe any wires of the SRS system.
- Disconnect the car battery before connecting work on the vehicle.
- Check behind panels before drilling any holes. Ensure that no wiring harness or other components are located behind the panels that would otherwise be damaged.
- Use conventional crimp lock, bullet on any wiring. Poor wiring, i.e. taped joints will possibly introduce unreliability into the alarm system and may result in false alarms or incorrect operation.
- Install wiring neatly under carpets or behind trim to prevent possible damage to wires.
- For the wire operates the current more than 10A. We suggest soldering all connection point. Do not use crimp lock type connectors or wire nuts.

## WIRING

Keep wires away from moving engine parts, exhaust pipes and high-tension cable. Tape wires that pass through holes on firewall to prevent fraying. Watch for sharp edges that may damage wires and causes short circuit.

CAUTION: Do not connect the wire harness to the control module until all wiring to vehicle is complete.

### H1: 6 PIN HEAVY GAUGE WIRING CONNECTION:

Remember that the system does to start a vehicle is duplicate the functions of the ignition key switch! Below, we will explain the three basic functions of the ignition switch. Since this installation will require analysis of the ignition switch functions, we recommend making the three connections below at the ignition switch harness directly.

#### H1/1. Violet Wire – Starter Output

Careful consideration for the connection of this wire must be made to prevent the vehicle from starting while in gear. Understanding the difference between a mechanical and an electrical Neutral Start Switch will allow you to properly identify the circuit and select the correct installation method. In addition you will realize why the connection of the safety wire is required for all mechanical switch configurations.

Failure to make this connection properly can result in personal injury and property damage.

In all installations it is the responsibility of the installing technician to test the remote start unit and assure that the vehicle can not start via RF control in any gear selection other than park or neutral.

In both mechanical and electrical neutral start switch configurations, the connection of the VIOLET wire will be made to the low current start solenoid wire of the ignition switch harness. This wire have +12 volts when the ignition switch is turned to the "START" (CRANK) position only. This wire have 0 volts in all other ignition switch positions.

NOTE: This wire must be connected to the vehicle side of the starter cut relay (when used). For the electrical neutral switch configuration, this connection must be made between the starter inhibit relay (when used) and the neutral safety switch as shown in the following diagram.

Failure to connect this wire to the ignition switch side of the neutral safety switch can result in personal injury and property damage. SEE NEUTRAL START SAFETY TEST FOR FURTHER DETAILS.

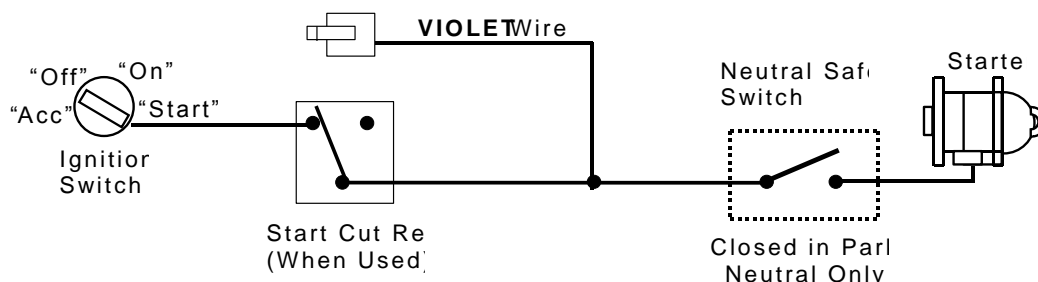

#### H1/2 & H1/3. Red Wire (2) – +12V Power Input

Remove the two 20A fuses prior to connecting these wires and do not replace them until the satellite has been plugged into the control module. These wires are the source of current for all the circuits the relay satellite will energize. They must be connected to a high current source. Since the factory supplies (+) 12V to the key switch that is used to operate the motor, it is recommended that these wires be connected there.

Note: If the factory supplies two separate (+) 12V feeds to the ignition switch, connect one RED wire of the satellite to each feed at the switch.

#### H1/4. Yellow Wire – Ignition 1 Output

Connect the YELLOW wire to the ignition 1 wire from the ignition switch. The ignition wire should receive "12 volts" when the ignition key is in the "ON" or "RUN" and "START" or "CRANK" position. When the ignition is turned "OFF", the ignition wire should receive "0" voltage.. **The Yellow wire must be connected.**

#### H1/5. Pink Wire – Ignition 2 Output

Some vehicles have [2] ignition wires that must be power. Connect the PINK wire to the ignition 2 wire from the ignition switch. The ignition wire should receive "12 volts" when the ignition key is in the "ON" or "RUN" and "START" or "CRANK" position. When the ignition is turned "OFF", the ignition wire should receive "0" voltage. If the PINK wire is not used, cap the end of the wire.

#### H1/6. Brown Wire –Accessory Output (Heater /ACC Output)

Connect the BROWN wire to the accessory wire in the vehicle that powers the climate control system. An accessory wire will show + 12 volts when the ignition switch is turned to the "ACCESSORY" or "ON" and "RUN" positions, and will show 0 Volts when the key is turned to the "OFF" and "START" or "CRANK" position. There will often be more than one accessory wire in the ignition harness. The correct accessory wire will power the vehicle's climate control system. Some vehicle may have separate wires for the blower motor and the air conditioning compressor. In such cases, it will be necessary to add a relay to power the second accessory wire.

### H2: 5 PIN WIRE HARNESS:

#### H2/1. Red / White Wire – Parking Light Relay Input --

The RED/WHITE wire is the input to the flashing parking light relay. The connection of the RED/WHITE wire will determine the output polarity of the flashing parking light relay.

If the vehicle you are working on has +12volt switched parking lights, you don't need connect this wire. This wire already connected to +12volt.

If the vehicle's parking lights are ground switched, cut the RED/WHITE wire, connect the RED/WHITE wire to chassis ground.

#### H2/2. White Wire –Parking Light Relay Output (+12 V 10A Output) --

Connect the WHITE wire to the parking light wire coming from the headlight switch. Do not connect the WHITE wire to the dashboard lighting dimmer switch. (Damage to the dimmer will result). The limitation of the WHITE wire is 10 AMP max. Do not exceed this limit or damage to the alarm and parking relay will result.

#### H2/3. Black Wire – System Ground –

This is main ground connection of the alarm module. Make this connection to a solid section of the vehicle frame. Do not connect this wire to any existing ground wires supplied by the factory wire loom, make the connection to the vehicle's frame directly.

#### H2/4. Brown Wire – Siren Drive Programmable Output – (See Alarm Feature III - 1 Programming)

This is the positive (+) output connection for the siren. Current capacity is 2 amps. Make connection to the (+) red wire from the siren. Make the (-) black wire coming from the siren to a good chassis ground.

#### H2/5. Red Wire –System Power (+12V Constant) --

The RED wire supplies power to the system. Connect this wire to a constant +12 volt source.

### H3. 2 PIN WHITE CONNECTOR FOR THE LED STATUS INDICATOR:

The led indicator status should be mounted in a highly visible area such as top of the dashboard, on top of the shifter console or on dashboard face. Leave at least 6mm space behind the mounting location for LED housing. Once a suitable location is chosen, drill a 6mm hole. Run the LED wires through the hole then press the 2 pin LED housing into the place. Route the LED wires to the control module.

### H4. 2 PIN BLUE CONNECTOR FOR THE VALET SWITCH:

Select a mounting location for the switch that is easily accessible to the driver of the vehicle. The switch does not have to be concealed, however, concealing the switch is always recommended, as this provides an even higher level of security to the vehicle. Mount the valet switch in a hidden but accessible location. Route the valet switch wires to the control module.

### H5: 6-PIN MINI WHITE CONNECTOR WIRE HARNESS:

#### H5/1. White Wire –(-) 200ma Programmable Output.

Dome Light Control Output (Factory Default Setting)—

This wire becomes grounded when the dome light controls circuit active. The current capacity of this wire is 200mA. This wire can control the operation of the interior lights. An optional 10 Amps relay can be used to this system for interior lights operation.

a). Upon disarming, the interior lights will remain on for 30 seconds.

b). If the vehicle is violated, the interior light will flash for the same duration as the siren.

**Horn Output**– See Alarm Feature III - 2 Programming)

This wire is provided to use the existing vehicle's horn as the alarm system's optional's warning audible device. It's a transistorized low current output, and should only be connected to the low current ground output from the vehicle's horn switch. When the system is triggered, the horn will sound.

**Factory Security Rearm Signal Output**– (See Alarm Feature III - 2 Programming)

This wire is designed to rearm a factory installed security system. This wire will supply a pulse whenever the remote start times out or is shut down using the transmitter and remote door locking..

**Ground Output During Start (Crank)** – (See Alarm Feature III - 2 Programming)

This wire will provide a 200 mA ground output while the starter output of the remote start unit is active. This output can be used to activate the Crank Low/Bulb Test wire found in some GM vehicles. This wire is also referred to as the ECM wake up wire in some vehicles.

**H5/2. Yellow Wire** – (-) 200ma Ignition 3 Output –

This wire provides a 200mA (-) ground output that becomes active 4 seconds before the remote start unit initialize, and remains grounded while running.

**Ignition 3 output:**

Some newer vehicles use a third ignition wire which is required to start and keep the vehicle's engine running. If this is the case, wire an IGN 3 relay (not supplied) as shown below:

Do not connect any vehicle circuits together, they are isolated for a reason.

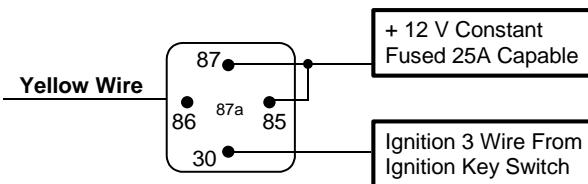

**Transponder interfacing using relay:**

If the vehicle has transponder system installed, you will need to by-pass the system while the vehicle is operating under the control of the Remote Start Unit. To do this:

1. You will need a transponder key that's already programmed to the vehicle.
2. Remove the trim around the ignition switch.
3. Wrap a thin (28 - 30awg) wire tightly around ignition switch 6 to 8 times and secure it.
4. About 6" down line make another loop of approximately 2" diameter.
5. Place the key inside this loop and secure it to the loop.
6. Connect on end of the (28 - 30awg) wire to pin (87) of the relay module.
7. Connect the other end of the loop wire to Pin (30) of relay module.
8. Connect the pin (86) of the relay module to the ignition wire from the ignition switch.
9. connect the pin (85) of the relay module to the **H5/2 Yellow** wire of 5-pin mini white connector.

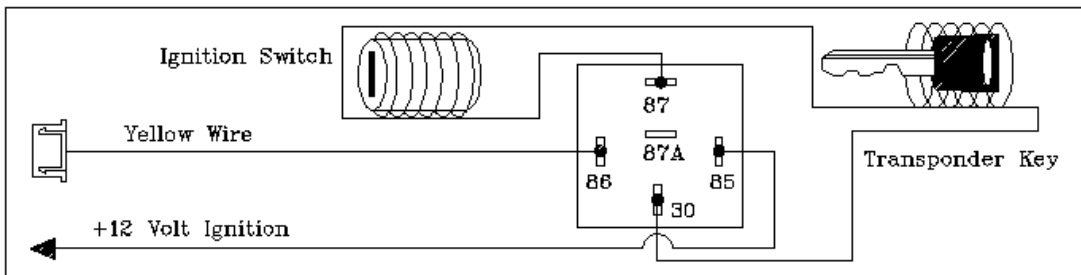



**GM VATS KEY OVERRIDE:**

If the vehicle has the General Motor VATS system installed, you will need to by-pass the system while the vehicle is operating under the control of the Remote Start Unit. To do this:

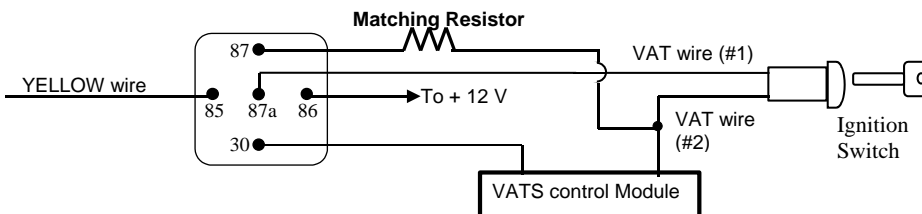
1. Measure the resistance of the resistor pellet on the ignition key then select a resistor within 5% of the key's value.
2. Locate the pair of VATS wires in the vehicle, usually a pair of thin gauge wires running from the ignition switch to the VATS control module.
3. Connect the YELLOW wire from Remote Start Unit to TERMINAL #85 of an external relay. Connect terminal #86 of the relay to a fused +12 volt.
4. Cut (#1) wire (as shown), and connect the ignition switch side of the cut wire to terminal #87a of the relay. Connect the other side of the (#1) wire to terminal #30.
5. Connect the previously selseed resistor from terminal #87 to the second(#2) wire (as shown).



### H5/3 Black / Green Wire – (-) 200mA Timer Control Channel 4 Output –

This wire is built-in user-programmable timer output provides a ground through this wire. Press the transmitter  and  buttons at the same time. You may program the built-in timer to send a ground signal for any time interval between 1 second and 2 minutes. For instance, this timer output may be used to turn on the headlight with the remote control. Also on certain BMW, Mercedes Benz, Jaguar and Volkswagen cars, you can use this unique timed output to allow remote closure of all power window and sunroof without the need for an external module! (See Alarm Feature III – 4 Programming) (Factory default setting on momentary grounded)

### H5/4 . Gray Wire – Channel 3 (Trunk Release) Output

This will become a 1 second pulse ground by activate channel 3 on transmitter for two seconds, the current capacity of this wire is 200 mA. This feature allows you to remote control trunk release or other electric device.

### H5/5. Pink Wire –(-) 200ma Programmable Output (See Alarm Feature III - 3 Programming)

#### 2 Steps Unlock Output – (Factory Default Setting) –

The 2 steps unlock feature will work for the most fully electronic door lock circuit. The vehicle must have an electronic door lock switch (not the lock knob or key switch), which locks and unlocks all of vehicle's doors. When wired for this feature, press the disarm (or unlock) button one time will disarm the alarm and unlock the driver's door only. If, press disarm (or unlock) button two times within 3 seconds, the alarm will disarm and all doors will unlock.

#### Factory Security Disarm Signal Output–

This wire is designed to disarm a factory installed security system. This wire sends a negative (-) 1 seconds pulse upon a remote start and remote door unlocking. Some factory systems must be disarmed to allow remote starting. In most cases, this wire may be connected directly to the factory alarm disarm wire. The correct wire will show negative ground when the key is used to unlock the doors or trunk. This wire is usually found in the kick panel area in the wiring harness coming into the car body from the door.

#### Start Status (Shock Sensor Bypass Control) Output –

This wire is designed to by-pass shock sensor module. This wire will supply an output at all times the remote start is operating plus an additional 3 seconds after the remote start unit turn off.

### H5/6 Orange Wire –(-) 500ma Grounded Output When Armed --

This wire will become grounded when the alarm is armed. The current capacity of this wire is 200mA. This output can control starter disable, when an intrusion is detected and the system is triggered. The vehicles prevent from any unauthorized starting.

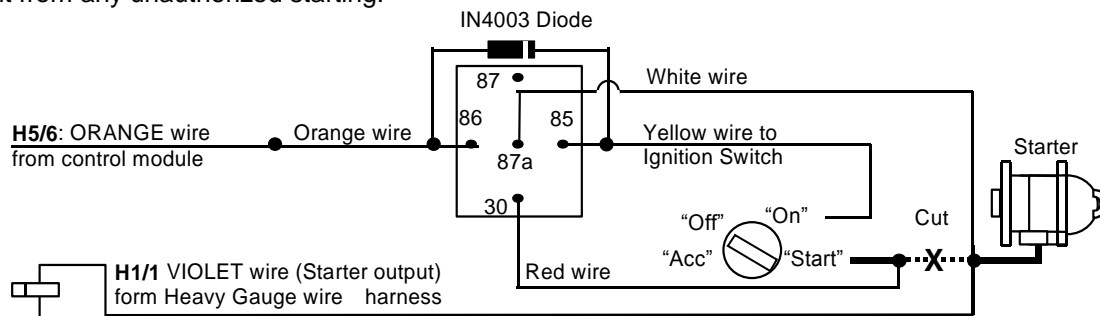

### H7: 7 PIN MINI BLACK CONNECTOR :

#### H7/1. Blue Wire – Ground Instant Trigger Input --

This wire is the ground trigger input wire for hood/trunk pin switches.

#### H7/2. Green Wire – Negative Door Switch Sensing Input --

This wire is the ground trigger input wire for negative door pin switch. This wire is connection for "grounding" type factory door pins locate the "common wire" that connects the door pin switches. Make the connection of the GREEN Wire here.

#### H7/3. Violet Wire – Positive Door Switch Sensing Input --

This wire is the positive trigger input wire for positive door pin switch. This wire is connection for "positive" type factory door pins (typical FORD MOTOR). Locate the "common wire" for all door pins and make the connection of the VIOLET Wire here.

#### H7/4 White / Blue Wire –(-) Instant Start & Turn Off Input –(See Alarm Feature III - 5 Programming)

This wires activates and turns off the remote starter each time it sees a momentary ground signal. Normally only used for testing during installation or when activating the module from an after-market system.

#### H7/5. White/Black Wire – Negative Safety Shut Down Input –

The WHITE/BLACK wire provides an instant shutdown for the remote start, whenever it is grounded. Connect the wire to the hood pin switch previously installed. This wire must be routed through a grommet in the firewall and connected to the hood pin switch. If the pin switch is to be used with an alarm system, connect this wire with diode.

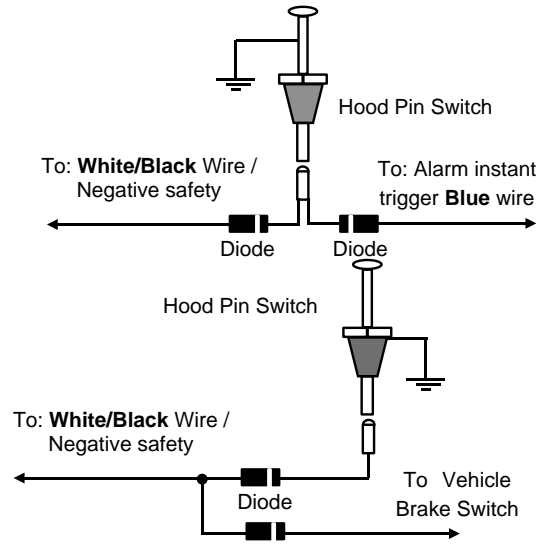

**Important!** This connection is a safety wire and must be connected as shown and tested as specified. Failure to do so may result in personal injury or property damage. See detail of wiring in the following diagram. This wire may also be used if the vehicle brake light circuit switches ground to the brake lights. An isolation diode must be used for ground switched brake light circuits and must be connected to the output of the brake switch.

**H7/6. BLACK/WHITE Wire – (-)Remote Start Enable Toggle Switch Input —  
— (-)Neutral Safety Switch Input —**

When the BLACK/WHITE wire is grounded, the remote start unit is operable. When this wire is open from ground, the remote start is disable.

1. The optional “remote start toggle switch” can be added on to temporarily disable the Remote Start Device, it can prevent the vehicle from being remote started accidentally. This feature is useful if the vehicle is being serviced or stored in an enclosed area. To disable the remote start, move the optional remote start enable toggle switch to the OFF position. To enable the remote start, move the optional remote start enable toggle switch to the ON position.
2. If needed, This wire can connect to the PARK/NEUTRAL switch in the vehicle. (See the TESTING YOUR INSTALLATION GUIDE)

**IMPORTANT NOTE: Directly connect the BLACK/WHITE wire to the “GROUND” when this wire is not used.**

**H7/7. White/Violet Wire – Positive Safety Shut Down Input**

This wire provides an instant shutdown for the remote start, whenever it gets +12volts. If the brake lights switch in the vehicle switches +12 volts to the brake light circuit, connect this wire to the output side of the brake switch. This will allow the remote start to shut down if an attempt is made to operate the vehicle without the key while running under the control of the remote start. In most vehicles, in order to shift gear, the brake pedal must be depressed. The brake input will in turn cause the remote start unit to shut off. See below diagram.

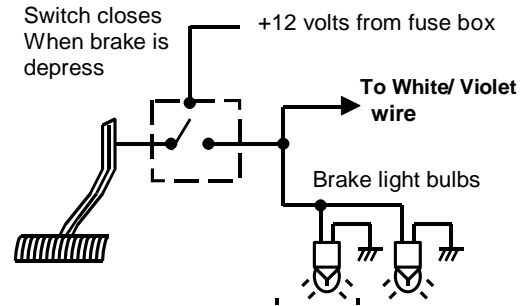

**H7/8. White /Red Wire – Tach. Signal connection—**

Note: You should connect this wire if you program the Start Feature II – 2 to “Engine checking TACH.” otherwise not to connect this wire and tap the end.

Note: No connection of this wire is required, if you use the voltage or timer checking type mode.

This input provides the remote start system with information about the engine’s revolutions per minute (RPM). It can be connected to the negative side of the coil in vehicle with conventional coils. In multi-coil and high energy ignition system locating a proper signal may be more difficult. Once connected, To test for a tach. wire, a multi-meter capable of test AC voltage must be used. The tach. wire will show between 1V and 6V AC at idle, and will increase as engine RPM increases. In multi-coil ignition system, the system can learn individual coil wire. Individual coil wires in a multi-coil ignition system will register lower amounts of AC voltage. Also, if necessary, the system can use a fuel injector control wire for engine speed sensing. Common locations for a tach. wire are the ignition coil itself, the back of the gauges, engine computers, and automatic transmission computers.

**IMPORTANT!** Do not test tach. wires with a test light or logic probe. The vehicle will be damaged.

How to find a tachometer wire with your multi-meter

1. Set the ACV or AC voltage (12V or 20V is fine.)
2. Attach the (-) probe of the meter to chassis ground.
3. Start and run the vehicle.
4. Probe the wire you suspect of being the tach. wire with the red probe of the meter.
5. If this is the correct wire the meter will read between 1V and 6V.

**Important Note: You must program the “Tach Signal” before trying to remote start.**



### H8. 4 PIN ORANGE CONNECTOR FOR 2 STAGE SHOCK SENSOR



### H9. BLACK 4-PIN CONNECTOR. – TWO-WAY TRANSCEIVER/ANTENNA MODULE

The Two-way transceiver/antenna mounts on the location above the belt line (dashboard) of the vehicle for best reception. We suggest you mount it on the lower left or upper left-hand side of windshield.

**Warning!** Do not mount in such a manner that it obstructs the driver's view.

- Remove the protective tape backing.
- Carefully align the two-way transceiver/antenna and apply to windshield.
- Route the black connector wire behind the trim and connect to the two-way transceiver/antenna.
- Connect the other end to the control module.
- Special considerations must be made for windshield glass as some newer vehicles utilize a metallic shielded window glass that will inhibit or restrict RF reception. In these vehicles, route the two ways transceiver/antenna module away from metallic shielded window glass as far as possible.

### H6. 3 PIN DOOR LOCK CONNECTOR:

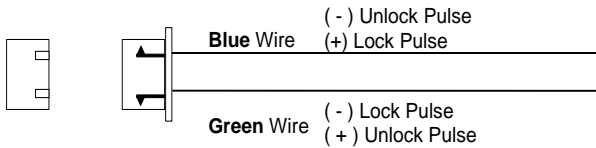

#### INSTALL NEW DOOR LOCK MOTOR

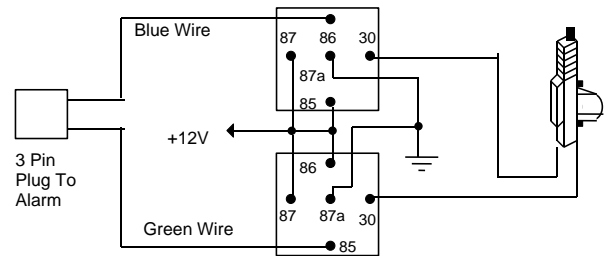

#### NEGATIVE TRIGGER DOOR LOCK SYSTEM

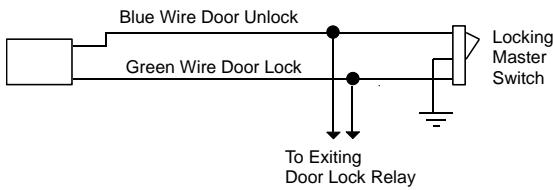

#### POSITIVE TRIGGER DOOR LOCK SYSTEM

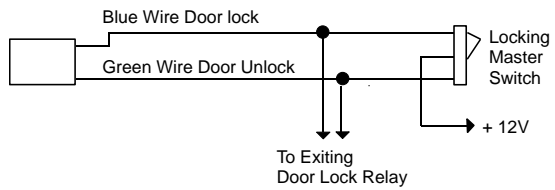

#### 5-WIRE ALTERNATING DOOR LOCK

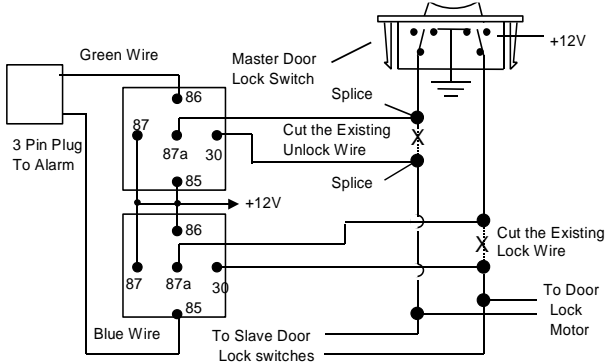

#### VACUUM OPERATED CENTROL LOCKING

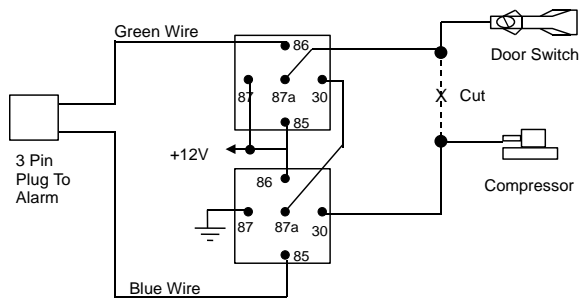



## B. ALARM FEATURES PROGRAMMING:

### ALARM FEATURE “I” PRORAMMING:

1. Turn the Ignition 'switch 'ON/OFF' 3 TIMES and stay in OFF position.
2. Push the Valet switch 2 times and holding in on 2<sup>nd</sup> push until **one** chirp with a long chirp is hearing then release the valet switch. You are now in the Alarm feature 'I' programming mode.
3. Press and release the transmitter button 'A' corresponding to the feature 'A' you want to change.
  - a. The siren chirps and LED pause will indicate newly setting.
  - b. The system would advance to [2] LED flash, [2] chirp. (The factory default settings is always [1] LED flash, [1] chirp.)
- 4 Depress the transmitter button 'A' again to change the feature again. Simple keep re-depressing the transmitter button 'A' again until the module advances to your desired setting.
5. Depress the transmitter button 'B' corresponding to the feature 'B' you wants to program.

| Press Transmitter Button | One Chirp / LED one pulse<br><b>Factory Default Setting</b> | Two Chirps / LED two pulse                  | Three Chirps / LED three pulse            | Four Chirps / LED four pulse |
|--------------------------|---|---|---|------------------------------|
| 1                        | All chirps on   | Siren chirp on only                         | Horn chirp on only                        | All chirps off               |
| 2                        | Active arming   | Passive arming without passive door locking | Passive arming with passive door locking. |                              |
| 3                        | Automatic Rearm on  | Automatic Rearm off                         |   |                              |
| 4 *                      | Instantly Door Ajar Warning                                 | 45 seconds delay Door Ajar Warning.         |   |                              |
| 5  + *                   | Without Car-jack mode                                       | Active Car-jack mode                        | Passive Car-jack mode                     |                              |

**Exit:** Turn Ignition to 'ON' position, or leave it for 15 seconds. A 3 long chirps & 3 parking light flashes to confirm exit.

#### 3 / 45 seconds Delay Door Ajar Warning:

This feature controls the error chirp that is generated if the system is armed with the door trigger active. This useful in a vehicle that has a long dome light delays after the door has been closed. If the system is armed before the dome light has turned off, the security system will generate the door trigger error chirp. Use this feature to disable the door open error chirp.

### ALARM FEATURE “II” PRORAMMING:

- 1 . Turn the Ignition 'switch 'ON/OFF' 3 TIMES and stay in OFF position.
- 2 . Push the Valet switch 4 times and holding in on the 4<sup>th</sup> push until **two** chirps with a long chirp is hearing then release the valet switch. You are now in the Alarm feature 'II' programming mode.
- 3 . Press and release the transmitter button 'A' corresponding to the feature 'A' you want to program.

| Press Transmitter Button | One Chirp / LED one pulse<br><b>Factory Default Setting</b> | Two Chirps / LED two pulse                              | Three Chirps / LED three pulse  | Four Chirps / LED four pulse                     |
|--------------------------|---|---|---|--|
| 1                        | 0.8-second Door lock pulses.                                | 3.5-second Door lock pulse.                             | Double pulse unlock   | Door lock with "Comfort Feature"                 |
| 2                        | Ignition controlled door locks & unlocks                    | Ignition controlled door locks only                     | Ignition controlled door unlocks only   | Without ignition controlled door locks & unlocks |
| 3                        | Door lock before start                                      | Door lock after shut-down                               | Door lock before start and Door lock after shut-down                                    | Without this feature                             |
| 4 *                      | Pathway illumination feature "off"                          | Parking light "on" for 30- second upon an unlock signal | Parking light "on" for 30- second upon an unlock signal & 10-second upon a lock signal. |  |
| 5  + *                   | Disable the out of range check.                             | Enable the out of range check                           |   |  |
| 6  + *                   | Override Without Password Pin Code                          | Override With Password Pin Code                         |   |  |

**Exit:** Turn Ignition to 'ON' position, or leave it for 15 seconds. A 3 long chirps & 3 parking light flashes to confirm exit.

**Comfort Feature:**

Some Vehicles have a special “COMFORT feature”. When you lock the door with the key, you just have to keep on turning the key on the door about 5 or 7 seconds and the window will close directly.

If your vehicle with “COMFORT feature” and you wish the door being locked and the window being closed automatically at the same time by remote control, You can set the alarm feature II-1 “with comfort feature”.

**Password Pin Code Setup:**

**Enter:**

1. Turn the Ignition 'switch 'ON/OFF' 3 times and stay in OFF position.
2. Push the Valet switch **4** times and holding in on the **4<sup>th</sup>** push until **two** chirps with a long chirp is hearing then release the valet switch. You are now in the Alarm feature ‘II’ programming mode.
3. Press and release the transmitter  and \* button at the same time twice, [2] LED flash, [2] siren/horn chirp to indicate your are in features “Password Pin Code Programming mode”.
4. Within 5 seconds, begin to enter your chosen first 9ths digit by pressing and releasing the valet switch from 1 – 9 times.
5. Within 15 seconds of the last entered 9ths digit, turn the Ignition switch to “ON” position.
6. Within 15 seconds, enter your chosen second 9ths digit by pressing and releasing the valet switch from 1 – 9 times.
7. Finish by turning the ignition switch to “OFF” position.

If the new password code was accepted, the unit would report back the newly entered code, by flashing the LED, first indicating the first digit code has been memorized, pause and then the second digit code. The unit will report the new code three times with a one-second’s pause between each code.

Note: If 15 seconds of inactivity expire, or if the ignition switch is turned “ON” for more then 5 seconds during of above steps, the unit will revert back to the last successfully stored code. A [3] long chirps to confirm exit.

Will

revert back to the last successfully stored code

**Delete Password Pin Code / Override Without Password Pin Code (Factory default setting):**

1. Turn the Ignition 'switch 'ON/OFF' 3 times and stay in OFF position.
2. Push the Valet switch **4** times and holding in on the **4<sup>th</sup>** push until **two** chirps with a long chirp is hearing then release the valet switch. You are now in the Alarm feature ‘II’ programming mode.
3. Within 15 seconds, press and hold the transmitter  and \* button at the same time for 3 seconds. A one long chirps to confirm Deleted the Password Pin Code.

**Example: To program the Password Code 92, you would;**



1. Turn the Ignition 'switch 'ON/OFF' 3 times and stay in OFF position.
2. Push the valet switch **4** times and holding in on the **4<sup>th</sup>** push until **two** chirps with a long chirp is hearing then release the valet switch. You are now in the Alarm feature ‘II’ programming mode.
3. Press and release the transmitter  and \* button at the same time twice, [2] LED flash, [2] siren/horn chirp to indicate your are in features “Password pin code programming mode”.
4. Within 5 seconds, press and release the valet switch 9 times.
5. Within 15 seconds of the last entered 9ths digit, turn the Ignition Switch to “ON” position.
6. Within 15 seconds press and release the valet switch two times.
7. Turn the Ignition Switch to “OFF” position.



You will note the LED flashing nine times, pause and then flash two times, pause. This pattern will be repeated three times indicating the new code (92) has been accepted and stored in memory.

**Exit:** Press any button of the transmitter to exit the password pin set up mode.

**ALARM FEATURE “III” PRORAMMING:**

1. Turn the Ignition 'switch 'ON/OFF' 3 TIMES and stay in OFF position.
2. Push the Valet switch **6** times and holding in on the **6<sup>th</sup>** push until **three** chirps with a long chirp is hearing then release the valet switch. You are now in the Alarm feature ‘III’ programming mode.
3. Press and release the transmitter button ‘A’ corresponding to the feature ‘A’ you want to program.

| Press Transmitter Button  | One Chirp / LED one pulse<br><b>Factory Default Setting</b> | Two Chirps / LED two pulse                    | Three Chirps / LED three pulse                         | Four Chirps / LED four pulse                         |
|---|---|---|--|--|
| 1  | H2/4 Brown Wire = Constant Siren output                     | H2/4 Brown Wire = 5-second pulse Siren output |  | H2/4 Brown Wire = Horn Output                        |
| 2  | H5/1 White Wire = Dome light Output                         | H5/1 White Wire = Horn Output                 | H5/1 White Wire = Factory Security Rearm Signal Output | H5/1 White Wire = Ground Output During Start (Crank) |

|   |  |  |   |  |
|---|--|--|---|--|
| 3      | H5/5 Pink Wire =<br>2-Step Door<br>Unlock Output                     | H5/5 Pink Wire =<br>Factory Security<br>Disarm Signal Output       | H5/5 Pink Wire =<br>Start Status (Shock<br>Sensor By-Pass<br>Control) Output                          |  |
| 4 *   | H5/3 Black / Green<br>Wire Channel 4<br>Output =<br>Momentary output | H5/3 Black / Green<br>Wire Channel 4<br>Output =<br>Latched output | H5/3 Black / Green<br>Wire Channel 4<br>Output =<br>Latched output and<br>reset with ignition<br>"on" | H5/3 Black / Green<br>Wire Channel 4<br>Output =<br>Timer programming<br>(set to any interval<br>between 1 second<br>and 2 minutes.) |
| 5  + * | H7/4 White / Blue<br>Wire =<br>1 pulse activate                      | H7/4 White / Blue<br>Wire =<br>2 pulse activate                    | H7/4 White / Blue<br>Wire =<br>3 pulse activate   |  |

**Exit:** Turn Ignition to 'ON' position, or leave it for 15 seconds. A 3 long chirps & 3 parking light flashes to confirm exit.

**Ground Output During Start (Crank)** = This wire will provide a 200mA ground output while the starter output of the remote start unit is active. This output can be used to activate the Crank Low/Bulb Test wire found in some GM vehicles. This wire is also referred to as the ECM wake up wire in some vehicles.

**Channel 4 Timer Control Output Programming.**

1. Turn the Ignition 'switch 'ON/OFF' 3 TIMES and stay in OFF position.
2. Push the Valet switch 6 times and holding in on the 6<sup>th</sup> push until **three** chirps with a long chirp is hearing then release the valet switch. You are now in the Alarm feature 'III' programming mode.
3. Press and release the transmitter \* button 4 times, [4] LED flashes, [4] siren/horn chirps to indicate your are in features "Channel 4 Timer Programming mode".
4. Press and hold the valet switch, the timer will immediately start.
5. When the desired interval has passed, release the valet switch. One long chirp for confirmation.  
(Set to any interval between 1 second and 2 minutes)

Note 1:

If your built-in timer controls window/sunroof closure in your car DO NOT change the timer setting! This requires installer-only programming. Changing the value will adversely effect operation and may cause damage.

Note 2:

**Momentary output** = The momentary output selection will output a negative signal from the Channel 4 (5/6) output immediately when the channel 4 (5/6) button is pressed and will continue until the button is release.



**Latched output** = The latched output selection will output a negative signal as soon as the Channel 4 (5/6) button is pressed and will continue until the button is pressed again.

**Latched output / reset with ignition** = The latched / reset with ignition output selection operates just like the latched output but will reset or stop when the ignition is turned on.

**REMOTE START FEATURE PROGRAM MODE**

**START FEATURE "I" PRORAMMING:**

1. Turn the Ignition 'switch 'ON/OFF' 3 TIMES and stay in OFF position.
2. Push the Valet switch 8 times and holding in on the 8<sup>th</sup> push until **four** chirps with a long chirp is hearing then release the valet switch. You are now in the Start feature 'I' programming mode.
3. Press and release the transmitter button 'A' corresponding to the feature 'A' you want to program.

| Press Transmitter Button  | One Chirp / LED one pulse<br><b>Factory Default Setting</b> | Two Chirps / LED two pulse                 | Three Chirps / LED three pulse             | Four Chirps / LED four pulse               |
|---|---|--|--|--|
| 1  | Gasoline Engine   | Diesel Engine and 10 seconds warn-up timer | Diesel Engine and 15 seconds warn-up timer | Diesel Engine and 20 seconds warn-up timer |
| 2  | 10 minutes run time   | 20 minutes run time                        | 30 minutes run time                        | 5 minutes run time                         |
| 3  | Factory alarm disarm with channel 3 on                      | Without this feature                       |  |  |
| 4 *   | Constant parking light output                               | Flashing parking light output              |  |  |

|        |  |  |   |  |
|--------|--|--|---|--|
| 5  +   | Press * - * button = Activate Remote Start.                                  | Press  + * button = Activate Remote Start.   | Press * button = Activate Remote Start.   |  |
| 6  + * | The Vehicle without Turbo (The system Cannot be Arm with the engine running) | The Vehicle has aftermarket Turbo timer installed:<br>The system Can be Arm with the engine running and the shock sensor will be bypass as long as the engine running.   | The Vehicle has aftermarket Turbo timer installed:<br>The system Can be Arm with the engine running and the shock sensor will be bypass for three minutes | Built-in Turbo Timer Control is Active:<br>Press  and * buttons at the same time to control Engine running one minute. |
|        |  | <b>Five chirps</b> = Built-in Turbo Timer Control is Active / Press  and * buttons at the same time to control Engine running three minutes.<br><b>Six chirps</b> = Built-in Turbo Timer Control is Active / Press  and * buttons at the same time to control Engine running five minutes. |   |  |
| 7  + * | 3 Hour Time start  | 2 Hour Time Start  |   |  |

**Exit:** Turn Ignition to 'ON' position, or leave it for 15 seconds. A 3 long chirps & 3 parking light flashes to confirm exit.

**SAFE START (Child safety mode)**

Factory defaults setting to press the \* button twice to start the vehicle.

Programming this feature to eliminate an accidental remote start, when kids enter this transmitter, it requires:

The user presses the transmitter and \* buttons at the same time to start the vehicle.

**START FEATURE “II” PRORAMMING:**

1. Turn the Ignition 'switch 'ON/OFF' 3 TIMES and stay in OFF position.
2. Push the Valet switch **10** times and holding in on the **10<sup>th</sup>** push until **five** chirps with a long chirp is hearing then release the valet switch. You are now in the Start feature 'II' programming mode.
3. Press and release the transmitter button 'A' corresponding to the feature 'A' you want to program.

| Press Transmitter Button | One Chirp / LED one pulse<br><b>Factory Default Setting</b>                               | Two Chirps / LED two pulse  | Three Chirps / LED three pulse | Four Chirps / LED four pulse |
|--------------------------|---|---|--------------------------------|------------------------------|
| 1                        | Exit the programming mode. (3 long chirp & 3 parking light flashes to confirm this exit.) |   |                                |                              |
| 2  +                     | Engine Checking TACH.   | Engine Checking Voltage   | Engine Checking OFF            |                              |
| 3                        | RPM learning  |   |                                |                              |
|                          | Start Timer:<br>0.6-second  | 0.8-second (2 chirps), 1.0-second (3 chirps), 1.2-second (4 chirps), 1.4-second (5 chirps), 1.6-second (6 chirps), 1.8-second (7 chirps), 2.0-second (8 chirps), 3.0-second (9 chirps), 4.0-second (10 chirps), |                                |                              |
| 4                        | Low check level   | Hi check level  |                                |                              |
| 5 * - *                  | Start / Stop the system for TESTING & ADJUSTMENT  |   |                                |                              |
| 6  + *                   | Without Shock sensor Test Mode  | With Shock Sensor Test Mode   |                                |                              |

**Exit:** Press the button on the transmitter. A 3 long chirps & 3 parking light flashes to confirm exit.

**ENGINE CHECKING TACH. / RPM LEARNING**

**Important Note:** You must program the “Tach Signal” before trying to remote start.

1. Turn the Ignition switch 'ON/OFF' 3 TIMES and stay in OFF position.
2. Push the Valet switch **10** times and holding in on the **10<sup>th</sup>** push until **five** chirps with a long chirp is hearing then release the valet switch.
3. Press and release the transmitter and buttons at the same time once to set the “Engine Checking TACH.” [1] LED flash, [1] chirp to confirm this setting.
4. Press and release the transmitter button once, [1] LED flash, [1] chirp to indicate the system in features “RPM Learning mode”.
5. Start the vehicle with the key. (While the engine is running, the parking light & LED will flash, If don't, please check tachometer White/Red wire connection. **(H7/8)**)

6. Press and hold the valet switch for 2 seconds until a long chirp and the LED light constant for two seconds. The RPM signal is learned.
  7. Turns off the ignition switch to stop engine running.
- Once you complete step 7, you can adjust and test “Check Level” as below:

### **CHECK LEVEL PROGRAMMING: (TEST and ADJUST)**

1. Press the \* button twice on the transmitter to start the vehicle.
2. If everything goes well:
  - a. Press the \* button twice on the transmitter to stop engine running. You have been completed this programming successfully.
  - b. Press the button on the transmitter to exit the program mode. There will be 3 long chirps & 3 parking light flashes for confirmation.
3. If the crank time is too short, (The engine did not successfully run before the starter quit cranking):
  - a. Press the \* button on the transmitter to turn ignition lights “OFF”.  
Press the button on the transmitter to set proper “Check Level” to Hi position. [2] LED flashes, [2] chirps to confirm this setting
  - b. Repeat the step1 – 4.
4. If the crank time is too long, (Engine is successfully running, while the starter is still cranking):
  - a. Press the \* button on the transmitter to stop engine running.  
Press the button on the transmitter to set proper “ Check Level ” to Low position. [1] LED flash, [1] chirp to confirm this setting
  - b. Repeat the step1 – 4.

### **ENGINE CHECKING VOLTAGE**

**Important Note:** The “Check Level” for most vehicles would be set in “Hi Check Level”, while in “Engine Check Voltage mode”, the “Check Level” must be set at “HI” position first.

1. Turn the Ignition 'switch 'ON/OFF' 3 TIMES and stay in OFF position.
2. Push the Valet switch 10 times and holding in on the 10<sup>th</sup> push until five chirps with a long chirp is hearing then release the valet switch.
3. Press the transmitter button and button at the same time to set the “Engine Checking Voltage”. [2] LED flashes, [2] chirps to confirm this setting.
4. Press the button on the transmitter to set “**Check Level**” to “**HI**” position. [2] LED flashes, [2] chirps to confirm this setting.



Once you complete step 4, you can adjust and test “Start Timer” as below:

### **START TIMER PROGRAMMING: (TEST and ADJUST)**

1. Press the \* button twice on the transmitter to start the vehicle.
2. If everything go well, Wait for 20 seconds:
  - a. If the engine still running.
    - I. Press the \* button twice on the transmitter to stop engine running. You have been completed this programming successfully.
    - II. Press the button on the transmitter to exit the program mode. There will be 3 long chirps & 3 parking light flashes for confirmation.
  - b. If the engine shut down after the vehicle has been started.
    - I. Press the \* button twice on the transmitter to turn ignition lights “OFF”.
    - II. Press the button on the transmitter to set “**Check Level**” to LOW position. [1] LED flash, [1] chirp to confirm this setting
    - III. Repeat the step1 – 2.
3. If the crank time is too long, (Engine is successfully running, while the starter is still cranking):
  - a. Press the \* button twice on the transmitter to stop engine running.
  - b. Press the button on the transmitter to set proper “Start Timer”. The chirp & LED pause will confirm this enter. (Decrease “Start Timer” is necessary.)
  - c. Repeat the step1 – 4.
4. If the crank time is too short, (The engine did not successfully run before the starter quit cranking):
  - a. Press the \* button twice on the transmitter to turn ignition lights “OFF”.
  - b. Press the button on the transmitter to set proper “Start Timer”. The chirp & LED pause will confirm this enter. (Increase “Start Timer ” is necessary.)
  - c. Repeat the step1 – 4.







### **ENGINE CHECKING OFF**

1. Turn the Ignition 'switch 'ON/OFF' 3 TIMES and stay in OFF position.
2. Push the Valet switch 10 times and holding in on the 10<sup>th</sup> push until five chirps with a long chirp is hearing then release the valet switch.

3. Press the transmitter  and  buttons at the same time to set the “Engine Checking Off”. [3] LED flash, [3] chirp to confirm this setting



Once you complete step 3, you can adjust and test “Start Timer” as below:

**START TIMER PROGRAMMING: (TEST and ADJUST)**

1. Press the  button twice on the transmitter to start the vehicle.
2. If everything goes well:
  - a. Press the  button twice on the transmitter to stop engine running. You have been completed this programming successfully.
  - b. Press  button on the transmitter to exit the program mode. There will be 3 long chirps & 3 parking light flashes for confirmation.
3. If the crank time is too long, (Engine is successfully running, while the starter is still cranking):
  - a. Press the  button twice on the transmitter to stop engine running.
  - b. Press the  button on the transmitter to set proper “Start Timer”. The chirp & LED pause will confirm this enter. (Decrease “Start Timer” is necessary.)
  - c.Repeat the step1 – 4.
4. If the crank time is too short, (The engine did not successfully run before the starter quit cranking):
  - a. Press the  button twice on the transmitter to turn ignition lights “OFF”
  - b. Press  button on the transmitter to set proper “Start Timer”. The chirp & LED pause will confirm this enter. (Increase “Start Timer ” is necessary.)
  - c.Repeat the step1 – 4.

**TEST AND ADJUST THE SHOCK SENSOR:**

The control module has built-in a two stage shock sensor. You can use “Test Mode” to test and adjust the shock sensor sensitivity.

- 1 Turn the Ignition 'switch 'ON/OFF' 3 TIMES and stay in OFF position.
- 2 Push the Valet switch **10** times and holding in on the **10<sup>th</sup>** push until five chirps with a long chirp is hearing then release the valet switch.
- 3 Press the  button and  button at the same time on the transmitter to enter the Shock Sensor Test mode, there will be a chirp confirmation for you to test shock sensor.
- 4 A light impact to the vehicle will activate the warn-away (first stage shock sensor/ **Zone 1**), system will emit a short chirp.
- 5 A more forceful impact will activate the full alarm (second stage shock sensor / **Zone 4**), system will emit a long chirp.
- 6 Continue to test the shock sensor until reach the proper sensitivity.

NOTE: Using a small screwdriver gently turns the adjustment screw



1. Turn the sensitivity adjustment screw to the “ - “ (anti-clockwise) direction for decreasing the sensitivity.
2. Turn the sensitivity adjustment screw to the “ + “ (clockwise) direction for increasing the sensitivity.

**Exit:** Press the  button on the transmitter. A 3 long chirps & 3 parking light flashes to confirm exit.



**RETURN TO FACTORY DEFAULT SETTING:**

1. Turn the ignition ON then OFF 3 TIMES and stay in OFF position.
2. Push the Valet switch **12** times and holding in on the **12<sup>th</sup>** push until **six** chirps with a long chirp is hearing then release the valet switch. You are now in the “Return To Factory Default Setting” programming mode.

**ALARM FEATURE ALL RETURNS TO FACTORY DEFAULT SETTING:**

3. Press and hold the  and  buttons on the transmitter together for 5 seconds, there will be a confirmation six chirp with 3 long chirp to confirm the system “Alarm Feature I & II & III Programming all returns to factory default setting.

**START FEATURE ALL RETURNS TO FACTORY DEFAULT SETTING:**

4. Press the  first, within 3 seconds press and hold the  and  buttons on the transmitter together for 5 seconds, there will be a confirmation six chirp with 3 long chirp to confirm the system “Start Feature I & II Programming all returns to factory default setting.

**SHUTDOWN DIAGNOSTICS**

The unit has the ability to report the cause of the last shutdown of the remote start system.

1. Turn the Ignition 'switch to 'ON position.
2. Press the  button on the transmitter.
3. The LED will now report the last system shutdown by flashing for 3 cycles in the following grouped patterns:

| LED Flashes | Shutdown Mode   |  |
|-------------|---|--|
| 1           | (-) Safety Shutdown input (Hood)or                                | 1. Close the hood.<br>2. Check H7/5 White/ Black wire connection.                    |
| 2           | (+) Safety Shutdown input (Brake) or Hand Brake (if installed) or | 1. Set the Hand Brake (if installed)<br>2. Check H7/7 White/ Violet wire connection. |



|   |  |  |
|---|--|--|
|   | Neutral Safety Switch input fail       | 3. Move the Enable Toggle Switch to "ON" position. (If installed.)<br>4. Move the gear selector to "Park"/ "NEUTRAL" position.<br>5. Check H7/6 Black/White wire connection. |
| 3 | No RPM (Engine Checking TACH.)or       | Check H7/8 White/Red wire connection   |
|   | Low Voltage. (Engine Checking Voltage. | Program the "Check Level" from "Hi Check Level" to "Low Check Level"   |
| 5 | Over-rev                               |  |
| 6 | System timed out                       |  |
| 7 | Transmitter                            |  |
| 8 | Tach. Signal has not been learned      | Re-learning the RPM (Start Feature II – 2 / 3)   |

### TESTING YOUR INSTALLATION:

**Caution!!** The follow procedure must be performed after the installation of the Remote Start Device. It is the responsibility of the installing technician to complete these tests. Failure to test the unit in the following manner may result in personal injury, property damage, or both.

1. Test the BRAKE shutdown circuit: With the vehicle in park (P), start the vehicle using the remote transmitter, Once the engine is running, press the brake pedal. The vehicle should shut down immediately. If the vehicle continues to run, check the brake circuit WHITE/ VIOLET wire (H7/7) connection.
2. Test the HOOD PIN shutdown circuit: Start the vehicle using the remote transmitter, Once the engine is running, pull the hood release and raise the hood. The vehicle should shut down immediately. If the vehicle continues to run, check the hood pin WHITE/ BLACK wire (H7/5) connection.

#### **3. NEUTRAL START SAFETY TEST:**

1. Set the vehicle parking brake.
2. Block the drive wheels to prevent vehicle movement.
3. Sitting in the vehicle, turn the ignition switch to "ON" or "RUN" position. But do not start the engine.
4. Step on the brake pedal and shift the gear selector into "DRIVE" (D).
5. Put your foot over the brake pedal but do not press down on it. Be ready to step on the brake to shut down the Remote Start Device.
6. Start the vehicle using remote transmitter.
  - a. If the starter does not engage, the test is complete.
  - b. If the starter engages, immediately step on the brake pedal to shut down the system, recheck your VIOLET wire (H1/1 starter output wire) connection. The heavy gauge VIOLET wire must be connected to the ignition switch side of the Neutral Start Switch. If the vehicle you are working on does not have an Electrical Neutral Safety Switch, it will be necessary to reconfigure the Remote Starts Wiring to accommodate this vehicle. The information concerning the Mechanical Neutral Safety Switch provided below will help you to determine if the vehicle you are working on has this type of safety switch and will provide alternate wiring methods to accommodate this situation.

#### **MECHANICAL NEUTRAL SAFETY SWITCH CONSIDERATIONS:**

Mechanical neutral safety switch configurations differ slightly in that they do not offer the same level of safety when installing a remote start device. Often when the ignition switch is turned off while the gear selector is in any position other than park or neutral, the mechanical function will not allow the key to be turned to the start position or be removed from the ignition cylinder. This configuration prevents mechanical operation while the vehicle is in gear but offers no consideration for electrical operation. Because of this potential problem, this installation requires the additional connection of a safety wire from the remote start device to the vehicle PARK/NEUTRAL ECM input or the vehicle key in sensor. This connection will prevent remote start operation if the key is left in the ignition switch regardless of the gear selector position.

#### **PARK/NEUTRAL ECM INPUT:**

The Park/Neutral ECM input is the preferred method of installation. This not only maintains the integrity of the factory circuit, it is also the easiest to install, providing the vehicle you are working on has this ECM input. The installation required for this application (shown below), indicates in the slight reconfiguration of the control switch wiring. Shown is a typical GM Park/Neutral ECM input circuit. To connect the Remote Start unit to the GM Park/Neutral ECM input:

1. Locate the Orange/Black reference wire in the "C2" connector found at the ECM in GM B Body vehicles or, locate the equivalent reference wire in the vehicle you are installing the Remote Start Unit in.
2. Connect the BLACK/WHITE Neutral Safety Switch wire (H7/6) to this reference wire.

**NOTE:** If the optional remote starts enable toggle switch is installed, connect the one side the enable switch to this reference wire and connect the other side of the enable switch to the BLACK/WHITE Neutral Safety Switch wire (H7/6) of the Remote Start unit.

The reference diagram below shows a typical GM B Body ECM reference wire and how it is to be connected to the Remote Start Unit.

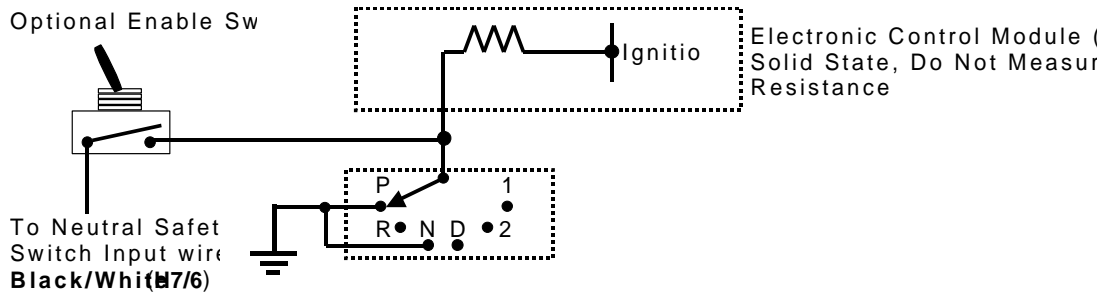

### KEY IN SENSOR CIRCUITS:

If the vehicle you are working on does not have or you cannot locate the ECM reference wire, there are two alternatives available. Although not preferred, the vehicle Key In Sensor may be reconfigured to allow a margin of safety and will prevent the vehicle with a Mechanical Neutral Start Switch from starting in gear. WE ADVISES THAT YOU MAINTAIN THE FACTORY CIRCUIT WHENEVER POSSIBLE. The following two circuits may be used only if the above circuit is not available.

**NOTE:** When completing an installation using either of the following key in sensor circuits, if the operator inserts the ignition key while the vehicle is running under the control of the Remote Start, the vehicle will shut down. This must be explained to the operator as it is in contrast to the normal operation of a vehicle utilizing an electrical neutral start switch and is inconsistent with the operators manual. Additional information concerning Key in Sensor methods 1&2 are listed below and should be reviewed before considering either alternative.

Method 1 will allow the safety required for the remote start unit and prevent the vehicle from starting while in any gear other than Park or Neutral while the key is in the ignition cylinder however, if the key is left in the ignition switch and the door is left opened, the added relay will be energized causing a 150mA drain on the battery. Method 2 will allow the safety required for the remote start unit and prevent the vehicle from starting while in any gear other than Park or Neutral while the key is in the ignition cylinder however, the original factory key in chime module will not alert the owner that the key has been left in the ignition switch. In addition, this may also effect other warning tones such as the light on reminder.

These situations should be carefully considered before altering the vehicle's wiring and must be fully explained to the consumer.

### METHOD 1

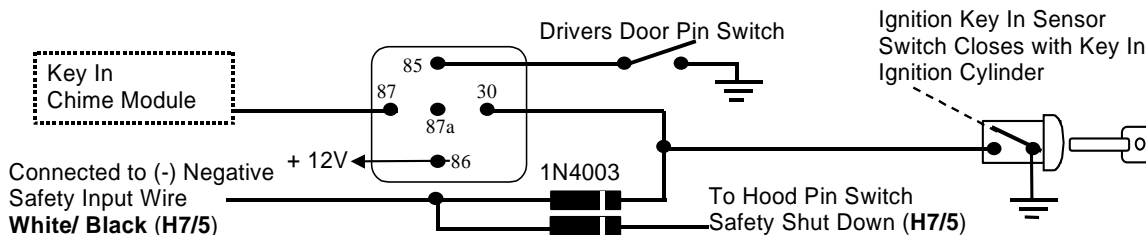

To connect to the key in sensor as shown in method 1:

- Locate the control wire that connects the drivers door pin switch to the key in sensor switch.
- Cut this wire and connect the ignition cylinder side to chassis ground.
- Locate the key in sensor switch wire that connects the chime module to the ignition cylinder.
- Cut this wire and connect the ignition cylinder side to terminal 30 of a P&B VF45F11 or equivalent relay.
- Connect the cathode (striped) side of a 4003 series diode to this same wire, and connect the (non striped) side to the negative safely input wire (WHITE/ BLACK) (H7/5) of the Remote Start Unit.
- Connect terminal 86 of the relay to a fused + 12 volt constant battery source.
- Connect terminal 87 of the relay to the Chime Module side of the previously cut wire in step D.
- Connect terminal 85 of the relay to the Drivers Door side of the pin switch wire previously cut in step B.

**Note:** A second 4003 series diode may be required to maintain the integrity of the hood open, shut down circuit. If this is the case, it must be installed as shown in the diagram above. The anode (Non Stripped) side must be connected to the WHITE/ BLACK wire (H7/5) of the Remote Start Unit. The cathode (Striped) side must be connected to the hood pin switch.

### METHOD 2

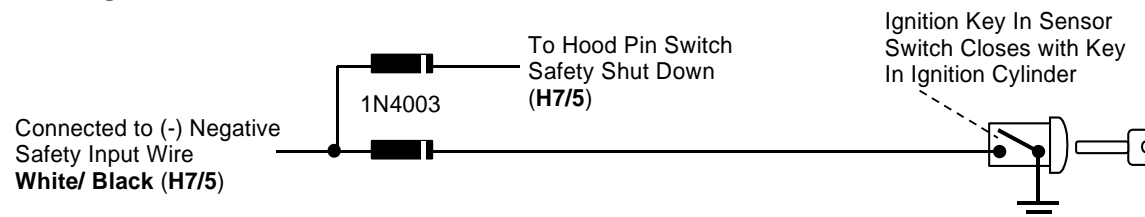

To connect to the key in sensor circuit as shown for method 2:

- Locate the control wire that connects the drivers door pin switch to the key in sensor switch.

- B. Cut this wire and connect the ignition cylinder side to chassis ground.
- C. Locate the key in sensor switch wire that connects the chime module to the ignition cylinder.
- D. Cut this wire and connect the ignition cylinder side to the Remote Start Negative Safety Shut down wire WHITE/ BLACK (H7/5), using a 4003 series diode as shown above.

**Note:** A second 4003 series diode may be required to maintain the integrity of the hood open, shut down circuit. If this is the case, it must be installed as shown in the diagram above. The anode (Non Striped) side must be connected to the WHITE/ BLACK wire (H7/5) of the Remote Start Unit. The cathode (Striped) side must be connected to the hood pin switch.

AFTER THE CONNECTION OF THE NEUTRAL START SAFETY WIRE AS INDICATED IN ANY OF THE PREVIUOS ALTERNATE CONFIGURATINS, THIS CIRCUIT MUST BE TESTED FOR OPERATION.

Retest by following the steps outlined in the NEUTRAL START SAFETY TEST shown in this manual. (D)

**WARNINGS:**

As with any product that performs automatic functions, there are certain safety precautions that you must practice and be aware of.

1. Keep the transmitter out of children's reach.
2. Do not leave anyone in the vehicle while running on remote control.
3. Alert servicing personnel that the vehicle can be started automatically.
4. Do not start the vehicle by remote while it's in an enclosed area or garage.
5. Always apply the parking brake and lock the vehicle as you exit the vehicle.
6. The vehicle windows must be rolled up.
7. Should the unit malfunction, disconnect the fuse until the problem is corrected.
8. The use and operations of this system is the sole responsibility of the operator.
9. Some areas may have local ordinances that prohibit leaving a vehicle running on public streets.
10. Do not start the vehicle by remote while the standard transmission vehicle is parked at a steep place.

**OPERATION:**

**A. REMOTE TRANSMITTER OPERATION:**

| Transmitter Button | System Function                         | Remark   |
|--------------------|---|--|
|                    | Lock Doors & Arm System                 |  |
| -                  | Arm and Delete The 2 Stage Shock Sensor | Press twice within 3 seconds                           |
| -                  | Arm System and Hidden Alarm Function    | Press within 3 seconds                                 |
|                    | Car Locator                             | Upon armed   |
| (3-second)         | Panic function                          | Press and Hold for 3 seconds.                          |
| +                  | Silent Arming / Disarming               | Ignition in "off" position.                            |
| +  (2-second)      | Active Anti Car-Jacking Mode            | Ignition in "on" position press and hold for 2 seconds |
|                    | Unlock Doors & Disarm System            |  |
| -                  | Two Steps Door Unlock & Disarm System   | Press twice within 3 seconds.                          |
| (2-second)         | Trunk Release (Channel 3)               | Press and Hold for 2 seconds                           |
| -                  | Passive Arming By-pass                  | While the system Disarmed.                             |
| * - *              | Activate or Turn Off The Remote Start   | Press twice within 3 seconds.                          |
| + *                | Turbo Time Mode                         |  |
| +                  | Channel # 4 Timer Output                |  |

**B. LED display:**

| LED        | Function       |
|------------|----------------|
| Off        | Disarmed       |
| Slow Flash | Armed          |
| Fast Flash | Passive Arming |
| On (Solid) | Valet Mode     |

| LED                | Function                            |
|--------------------|-------------------------------------|
| 2 flashes... pause | Zone 2 / Trigger on Trunk/Hood      |
| 3 flashes... pause | Zone 3 / Trigger on Door Switch     |
| 4 flashes... pause | Zone 4 / Trigger on Shock Sensor    |
| 5 flashes... pause | Zone 5 / Trigger on Ignition Switch |

**C. CHIRP INDICATORS:**

| Chirp    | Function           |
|----------|--------------------|
| 1 chirp  | Arm                |
| 2 chirps | Disarm             |
| 3 chirps | Ajar Warning       |
| 4 chirps | Disarm / Triggered |
| 6 chirps | Car Locator        |

**D. PARKING LIGHT:**



| Parking light | Function           |
|---------------|--------------------|
| 1 flash       | Arm                |
| 2 flashes     | Disarm             |
| 3 flashes     | Disarm / Triggered |
| 12 flashes    | Car Locator        |
| Constant On   | Under Remote Start |

## E. ALARM OPERATING CONDITION:



|                | Siren / Horn  | Parking Light  | LED        | Doors     | Starter | Dome Light              |
|----------------|---------------|----------------|------------|-----------|---------|-------------------------|
| 1. Arming      | 1 or 3 Chirps | 1 Flash        | Slow Flash | Locking   | Disable |                         |
| 2. Disarming   | 2 or 4 Chirps | 2 or 3 Flashes |            | Unlocking |         | Turns on for 30 -second |
| 3. Trigger     | Alarming      | Flashes        | Slow Flash |           | Disable | Flashes                 |
| 4. Panic       | Alarming      | Flashes        |            |           |         | Flashes                 |
| 5. Car-Jacking | Alarming      | Flashes        |            |           | Disable | Flashes                 |
| 6. Car Locator | 6 Chirps      | 12 Flashes     |            | Locking   |         |                         |

## F. ACTIVE ARMING – LOCK & ARM

1. Press  button on the transmitter.
2. The siren will chirp once and parking light will flash once indicating that the system is now armed. The vehicle door will lock and dome light turns on for 10 seconds upon arming when interfaced with the security system.

**SILENT ARMING / DISARMING:** Press the transmitter  and  buttons at the same time will arm or disarm your security system, No chirp sound will be heard, arm / disarm confirmation will be through the vehicles parking lights only.

**SHOCK SENSOR BY-PASS:** Press the  button on the transmitter two times within 3 seconds will arm the security system and by-pass the shock sensor. The system will chirp one additional time to confirm the sensor bypass mode was activated. The sensor bypass feature is programmed to activate for one arming cycle only. The security system will return to normal operation during the next arming cycle.

**HIDDEN ALARM FUNCTION:** Press the  button first; within 3 seconds press the  button to activate the hidden alarm function. The security system will arm and with “Hidden Alarm Function”. The siren / horn will be silenced even if the sensor is triggered in the armed status.



## G. PASSIVE ARMING

Active arming / disarming is controlling your security system via the remote transmitter. This security system is equipped with an optional Passive Arming feature, which allows the security system to arm 30 seconds after the last door is closed. Operation is as follows.

1. Turn the ignition to the “OFF” position and exit the vehicle.
2. After all entrances are closed, the security system LED will flash fast for 30 seconds. If you reopen any door / hood / trunk, the security system LED will stop flashing. It will begin flashing again once the vehicle all entrances are closed.
3. After 30-second timer has elapsed, the security system will automatically “ARM”. The siren will chirp [1] time and the parking lights will flash [1] time.

**PASSIVE ARMING WITH PASSIVE DOOR LOCKING** (See Alarm Feature “I - 2” Programming):

The vehicle doors will automatically lock after passive arming cycle has been completed.

**PASSIVE ARMING BY-PASS:** While the system disarmed, Press the  button twice, the security will respond with [1] chirp and LED will turn “ON”. The security system will remain in this temporally state for as long as you wish. To exit passive by-pass, press the transmitter  or  button and the system will return to normal status.

## H. ACTIVE DISARMING – UNLOCK & DISARM

1. Press  button on the transmitter.
2. The siren will chirp **once** and parking light flash **once** to indicating that the security system is now disarmed. The vehicle’s door will unlock and dome light turns on for 30 seconds upon disarming when interfaced with the security system.

**TAMPER DISARMING:** If alarm triggered, upon disarm the system, siren chirp 4 times, parking light flash 3 times.

**PATHWAY ILLUMINATION** (See Alarm Feature “II - 4” Programming): This feature turns the parking light “ON” for 30 seconds upon a unlock signal and for 10 seconds upon the lock signal.

**TWO STEPS DOOR UNLOCK** (See Alarm Feature “II - 1” Programming): This feature will independently unlock the driver’s door only when disarming the security system. Pushing the  button a second time within 3 seconds will unlock the other doors.

**AUTOMATIC RE-ARM** (See Alarm Feature “I - 3” Programming): If this feature is selected, the security system will automatically re-arm itself in 60 seconds after disarming with remote transmitter. Automatic rearm will cancel if any door is opened before the 60 seconds timer has elapsed.

## I. DISARMING WITHOUT A TRANSMITTER (Alarm Feature II - 6 Programming)

**OVERRIDES THE ALARM WITHOUT PASSWORD PIN CODE:** (Factory Default Setting)

The Override function may be used if the remote transmitter is lost or inoperative.

1. Enter the vehicle and turn the ignition switch to 'ON' position. (Alarm will sound.)
2. Within 10 seconds push and release the valet switch

The alarm will stop sounding and enter the disarm mode. You can now start and operate the vehicle normally.

#### **OVERRIDE THE ALARM WITH PASSWORD PIN CODE: (Alarm Feature II - 6 Programming)**

Unlike valet switch easily found, and defeated, this security system allows the consumer to program a password pin code. Offering a higher level of security.

1. Enter the vehicle and turn the ignition switch to 'ON' position. (Alarm will sound.)
2. Within 5 seconds, enter your chosen the first digit code by press and release the Valet Switch.  
(When finished above procedures, system's siren stop alarming, parking light stop flashing, but the vehicle cannot be start and drive away.)
3. Within 15 seconds of the last digit code enter (the 1st code), turn the Ignition Switch "OFF" and then "ON".
4. Within 15 seconds, enter your chosen of the second digit code by press and release the Valet Switch.
5. Turn the ignition switch "OFF" position. [4] Chirps form siren/horn, [3] flash from parking light to indicate the system was disarmed.

**Note:** You must override the alarm within 60 seconds. If not, the system will automatically re-arm.

#### **EXAMPLE: To Override The System With The Password Code 83, you would;**

1. Enter the vehicle and turn the ignition switch to 'ON' position. (Alarm will sound.)
2. Within 5 seconds, Press and Release the Valet Switch 8 times  
(When finished above procedures, system's siren stops alarming, parking light stop flashing, other sensor stop trigger, but the vehicle can not be start and drive away.)
3. Within 15 seconds of the last digit code enter (the 1<sup>st</sup> code), turn the Ignition Switch "Off" and then "ON".
4. Within 15 seconds, Press and Release the Valet Switch 3 times
5. Turn the Ignition Switch to "Off" position. [4] Chirps form siren/horn, [3] flash from parking light to indicate the system was disarmed.

#### **J. VALET MODE (System in Disarm or Valet mode)**

The valet switch allows you to temporarily bypass all alarm function, eliminating the need to hand your transmitter to parking attendants or garage mechanics. When the system is in valet mode, all alarm function and remote start functions are bypassed, however the remote panic feature and remote door locks will remain operational. To use the valet mode, the system must first be disarmed either by using you remote transmitter, or by operating the Manual override sequence.

##### **Enter Valet Mode:**

1. From the disarmed condition, turn the ignition to "ON" position.
2. Push and hold valet switch for 2 seconds until the LED turns on. The LED will remain on as long as the system is in 'valet mode'.

##### **Exit Valet Mode:**









1. Return to normal operation, turn ignition 'on'.
2. Push and hold valet switch for 2 seconds, The LED wills turns off indicate the system are exiting the valet mode.

#### **K. CAR LOCATOR**

Under armed mode, press the  button to active car locator function. The siren will chirp 6 times. The parking light will flash 12 times, for you to easily locate your car.

#### **L. PANIC FUNCTION**

The transmitter can be used as a remote panic switch to manually trigger the alarm in case emergency.

1. Press and hold the  button for 3 second. The alarm will immediately sound.
2. During panic mode, the normal function of this transmitter button will be suspended. The transmitter  and  buttons can be used to lock and unlock the door (if the option is installed), however once the  button is pressed, the vehicle's starter disable device, (where installed) will be enable allowing the vehicle to start.
3. To stop the alarm, press and hold the transmitter  or  button on the transmitter again for 3 seconds.  
Also if any transmitter buttons other than  or  button is pressed and released, the panic mode will be turned off immediately.
4. If the button is not pressed, the alarm will automatically stop after 30 seconds.

#### **M. TRIGGER THE SYSTEM**

When armed, your vehicle is protected as follows:



1. Light impact will trigger the warn-away signal.
2. Heavy impacts / Doors open / Hood open / Trunk open / Turn on the ignition key will trigger the programmed sequence.

The starter disable relay (if installed) prevents the vehicle's starter from cranking. The siren, horn, parking lights, and dome light will turn on to alerting of an intrusion for 30 seconds. Then it will stop and automatic reset and re-arm. If the one of sensors or detectors still active, the alarm system will sound a maximum of 6 times of 30 seconds cycles.

#### **N. ANTI CAR- JACKING**

**Warning:** If you don't need the car jacking function in this alarm system, be sure to set car jacking feature "OFF". This system is default setting all car-jacking "OFF". (See Alarm Feature I - 5 Programming)

**ACTIVE ANTI CAR JACKING:**

1. Press and hold the transmitter  and  buttons at the same time for 2 seconds while the vehicle's ignition is ON. The parking lights will turn on for 1.5 seconds to indicate the system enters the car-jacking mode.
2. Once the system is in car-jacking mode, if you are forced from the vehicle, the system will trigger when the door is opened and closed while the ignition is "ON".

**PASSIVE ANTI CAR- JACKING:**

1. Turn the ignition switch to "ON" position; the system enters the car-jacking mode.
2. Once the system is in car-jacking mode, if you are forced from the vehicle, the system will trigger when the door is opened and closed while the ignition is "ON".

**TRIGGER THE ANTI CAR -JACKING MODE:**

- a). 50 seconds after the system has been triggered. The siren will start chirping for 15 seconds.
- b). During this 15 seconds period of chirping, you will be alerted to push the valet switch once to turn off the car-jacking feature. If not, it will enter second timer car jacking.
- c). 65 seconds after the system has been triggered. The siren starts alarming and the parking light starts flashing.
- d). 90 seconds after the system has been triggered
  1. The siren still alarming and the parking light flashing, and
  2. The starter disable will activate to prevent the vehicle from starting.
  3. It will remain active until the vehicle's battery power is exhausted.

**OVERRIDE THE SYSTEM TO TURN OFF ANTI CAR- JACKING:**

Turn the ignition switch from OFF to ON, and within 10 seconds push valet switch, the siren will stop and the system is disarmed.

**Note:** If you use password pin code to double protect the vehicle security, you will need to use it to completely disarm the system.

**O. DOME LIGHT CONVENIENCE DELAY & SUPERVISION**

The alarm has a unique feature which will turn on your vehicle dome light as follows:

1. Upon disarming, the interior light will remain on for 30 seconds.
2. If the vehicle is intruded, the interior light will flash for the same duration as the siren.

Note: Turn on the ignition switch or arm the alarm will turn off the dome light.



**P. IGNITION CONTROL DOOR LOCK/UNLOCK** (See Alarm Feature II – 2 Programming)

If the vehicle's door locks have been interfaced to the security system, the system will automatically lock the vehicle's doors when the ignition is turned "ON" and /or unlock the vehicle's doors when the ignition is turned "OFF".

**Q. TRUNK RELEASE (CHANNEL 3) OUTPUT**

Press and hold  button on the transmitter for two seconds to remote control the trunk release or other electric devices.

**R. CHANNEL 4 TIMER CONTROL OUTPUT** (See Alarm Feature III – 4 Programming)

Press the transmitter  and  buttons at the same time to activate Channel 4 function. Channel 4 is a user-programmable timer output. You may program the built-in timer to send a ground signal for any time duration from 1 second to 120 seconds. For instance, this timer output may be used to turn on the headlight, power window or sunroof. (Factory default setting at momentary output.)

**S. POWER ON MEMORY**

This security system is equipped with circuitry that will allow the unit to remember its alarm state if the power is lost and then reconnected.

**REMOTE START OPERATION:**

**A. TO REMOTE START THE VEHICLE:**

1. Press  button twice on the transmitter.
2. The parking light will activate to indicate the remote start received the signal.
3. The engine will start approximately 5 seconds.
4. Once the engine is running, after a couple seconds the parking light will turn on again and climate controls will activate and adjust the vehicle's interior temperature to your preset setting.
5. The vehicle will run for a 5 to 30 minute cycle and automatically shut down.

**Note:** The Remote Start Unit will not start the vehicle if any one of the following conditions exists:

1. The hood is opened.
2. The brake pedal is pressed.
3. Move the optional remote start enable toggle switch to OFF position. (If installed)
4. The gear selector is in any gear other than "PARK" or "NEUTRAL"

### **SAFE START (Child safety mode)** (See Start Feature I – 5 Programming)

Factory defaults setting to press the \* button twice on the transmitter to start the vehicle. Programming this feature to eliminate an accidental remote start, when kids enter this transmitter, it enquires:

The user presses the transmitter  and \* buttons at the same time to start the vehicle.

### **B. TO OPERATE THE VEHICLE WHILE RUNNING ON THE REMOTE START:**

To operate the vehicle while engine running on the remote start:

1. Insert the ignition key and turn it to “ON” (not the start) position.
2. Press the brake pedal.

**Note:** If the brake pedal is pressed before the key is in the ON position, the engine will shut down.

### **C. TEMPORARY STOP FEATURE:**

This feature allows the vehicle to remain running after the key has been removed from the ignition. This feature is useful for occasions when you wish to exit and lock the vehicle for short periods of time, but would like to leave the motor running and the climate control on.

1. Before turning off the engine, press the \* button twice on the transmitter and the LED indicator will flash 3 times to confirm enter.
2. Turn the ignition key to OFF position. (The engine will stay running.)
3. The engine will run until the pre-programmed time elapsed or shutdown input is received.

### **E. TURBO TIMER MODE:** (See Start Feature “I - 6” Programming)

Turbo timer mode keeps the engine running after arriving at you destination for a programmable period of 1/ 3 or 5 minutes. This allows the system’s time to conveniently cool down the turbo after you have left the vehicle. To activate:

1. While engine is running, place the transmission gear in the park position and pull up the hand brake.
2. Before turning off the engine, press and release  and \* buttons at the same time.  
-- The parking light will turn on to indicate the remote start has entered turbo charge mode. --
3. Pull off the “Ignition Key” from the key cylinder.  
-- Engine keeps running. --
4. Exit and secure the vehicle.  
-- Engine continues running until the pre-programmed time elapsed. --

### **F. TIMER START:** (See Start Feature “I - 7” Programming)

This unit can be programmed to start and run the engine every 3 (2) hours. The engine will run for the programmed running time and then shut down.

**IMPORTANT:** Timer Start should be used only in open areas, never start and run the vehicle in an enclosed space as a garage or carport.

This feature is design for an extreme cold climate usage. The system will auto start the vehicle every 3 (2) hours, to prevent engine freezing and hard to start.

A MAXIMUM OF SIX CYCLES CAN OCCUR.

#### **ENTER:**

1. Press the \* button twice to remote start the vehicle. As soon as the vehicle is running and the parking light have turned on or flashing.
2. Immediately depress the  button once, within 2 seconds
3. Rapidly depresses the \* button. The parking light will flash (3) times. The siren or horn chirps (3) times. The vehicle is now programmed to start every 3 (2) hours.
4. Press the brake pedal to stop the vehicle running.

#### **Exit the timer start:**

Timer start can be exited manually as follows:

Make sure the remote start system is not operating the engine.

2. Turn the ignition on. The LED and parking light will flash (4) times. The horn chirps (4) times.

Or

1. Press the \* button twice to remote start the vehicle. As soon as the vehicle is running and the parking light have turned on or flashing.
2. Immediately depress the  button then press and hold the \* button for 2 seconds. The parking light will flash (4) times. The siren or horn chirps (4) times. The vehicle is no longer programmed to start automatically.

### **G. TO TURN OFF THE REMOTE START:**

When the engine is running (by remote start), if you want to stop it,

1. Press \* button twice on the remote transmitter under remote start mode.
2. Move the optional remote start enable toggle switch to OFF position. (If installed)
3. Press the brake pedal

The vehicle will shut down and turn off the parking light to indicate engine stopped.

### **H. SHUT-DOWN INPUT FOR REMOTE STARTER:**

If any of the following conditions exist while the system is operating, the engine will not start or will shut down immediately:

1. The hood is opened.
2. The brake pedal is pressed.
3. Engine is over-revved. {"Tachometer checking type" only}
4. The pre-programmed run time (5 /10 / 20 / 30 minutes) has elapsed.
5. Press \* button twice on the remote transmitter under remote start mode.
6. Move the optional remote start enable toggle switch to OFF position. (If installed)
7. The vehicle refused to start running after {3} unsuccessful attempts.

**I. DISABLING THE REMOTE START SYSTEM:** (If installed)

This feature allows your system's remote start unit to be temporarily disabled to prevent the vehicle from being remote started accidentally. This feature is useful if the vehicle is being serviced or stored in an enclosed area. To disable the remote start, move the optional remote start enable toggle switch to the OFF position.

**J. 2-WAY UPGRADE:**

This unit is capable of 2-way communication to notify the owner if anyone is trying to tamper with the vehicle or to confirm remote start operation. If you would like to upgrade this unit to a 2-way system, please contact: Megatronix ([www.megatronixusa.com](http://www.megatronixusa.com))

This device complies with part 15 of the FCC rules. Operation is subject to the following two conditions.

- (1) This device may not cause harmful interference, and
- (2) This device must accept any interference received, including interference that may cause undesired operation.