

MEGALARM®

MEGA 310

DELUXE 4-CHANNEL MOTORCYCLE
ALARM SECURITY SYSTEM

Installation And Operation Manual



MEGATRONIX
CALIFORNIA, U.S.A.

INSTALLATION

We recommend insulating all your soldered or crimped connections with heat shrink or electrical tape. We also recommend spraying silicone sealant on all your connections and plugs after they are connected and plugged in, spraying beforehand prevents good electrical connections.

Keep wiring away from moving engine parts, exhaust pipes and high-tension cable. Tape wires that pass through holes on the firewall to prevent fraying. Watch out sharp edges that may damage wires and cause short circuit.

A. MOUNTING CONTROL MODULE:

Mount the control module with the tie-wraps or with the screws.

1. The control module and all of its components **MUST** be installed in a location where they cannot become wet and be submerged in the water.
2. Keep it away from any heat sources or obvious leaks. Also keep the components and harnesses as far from the exhaust as possible.
3. The higher the control module is mounted, the better the transmitter range will be.

B. MOUNTING THE SIREN (OPTIONAL):

1. Place the siren in a location suitable for best sound results. Be careful not to mount the unit near exhaust manifolds or other "hot" equipment and moisture area.
2. Mount it where a thief cannot easily disconnect it. Both the siren and its wires should be difficult to find. This usually involves disguising the wire to look like a factory harness.
3. Preferred siren position is facing down so water does not collect in it.
4. When installing this system in watercraft, the siren must be mounted in a compartment that does not take in water.

D. INSTALLING THE OVERRIDE/VALET/PROGRAM SWITCH:

The override/valet switch **MUST** be installed in a location where they cannot become wet and be submerged in the water and in a hidden but accessible location. Drill a 1/4" hole at the location chosen and use the nut and lock washer provided to secure the override/valet switch. Route this wire to the control module.

C. INSTALLING THE LED STATUS INDICATOR:

1. The led indicator status should be visible from both side and rear of the motorcycle,
2. It need at least 1/2 inch clearance to the rear.
3. The LED fits in a 9/32 inch hole.

E. TRANSMITTER ANTENNA MODULE (FOR 2-WAY SYSTEMS):

Mount the transmitter antenna module with the tie-wraps or tape.

1. The antenna module and all of its components **MUST** be installed in a location where they cannot become wet and be submerged in the water.
2. Keep it away from any heat sources or obvious leaks. Also keep the components and harnesses as far from the exhaust as possible.
3. Mount the antenna module in a hidden but accessible location
4. Keep it away from large metal objects or chassis for best reception.

WIRING DIAGRAM

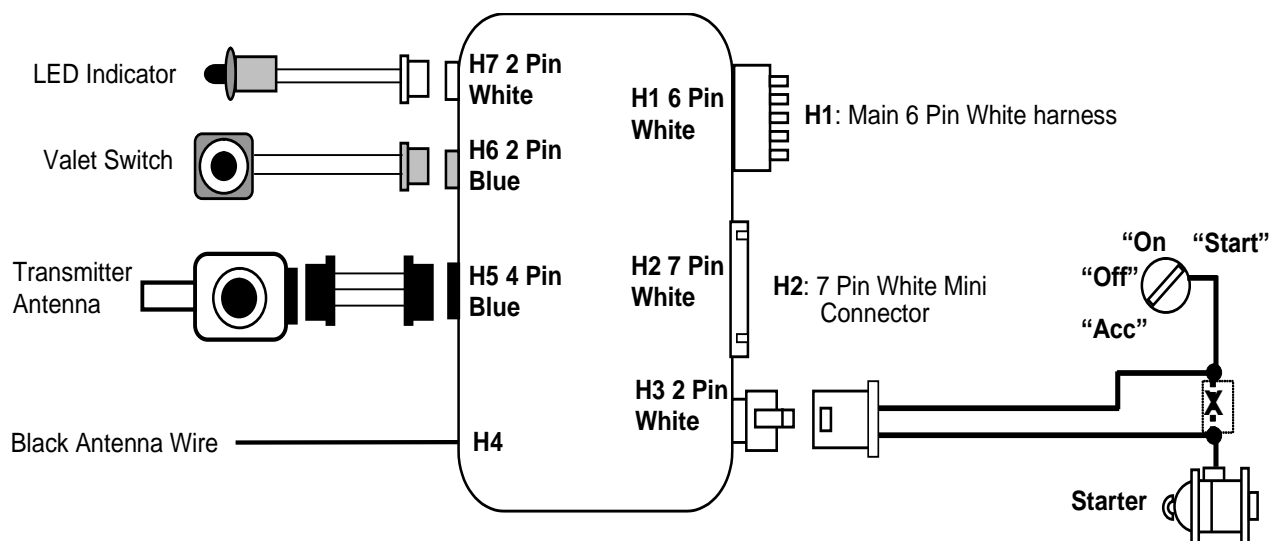

H1: MAIN 6 PIN WIRE HARNESS:

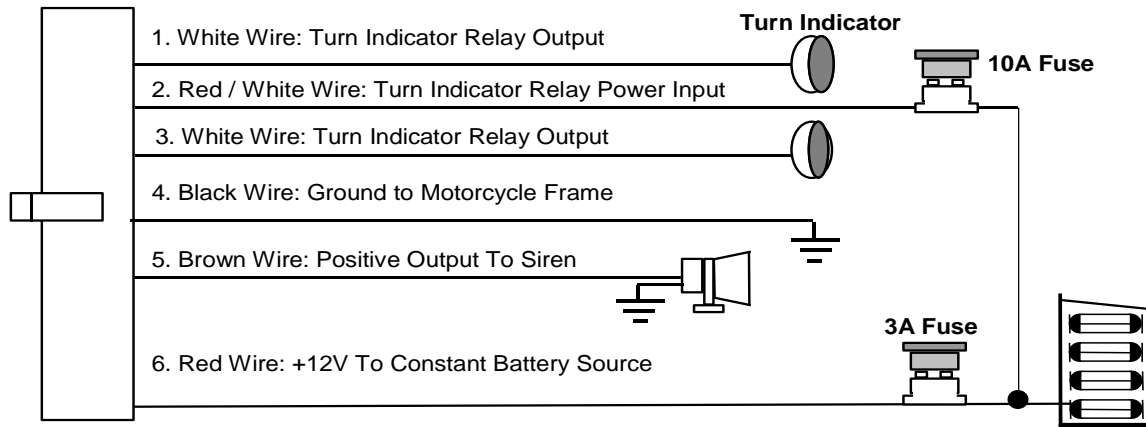

H3: 7 PIN MINI CONNECTOR WIRE HARNESS:

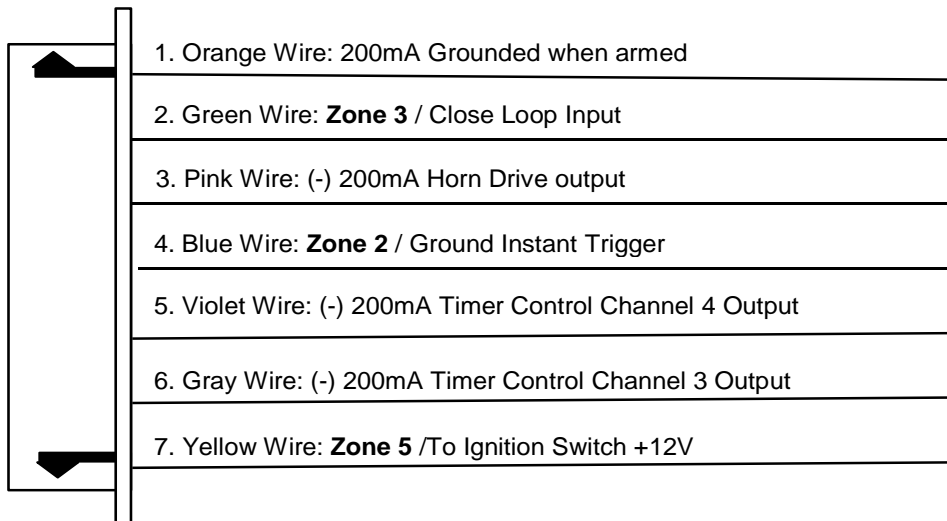

WIRING

CAUTION: Do not connect the wire harness to the control module until all wiring to motorcycle is complete.

H1. MAIN WIRE HARNESS:

H1/1 & 3. White wire – (+) Turn Indicator Relay Output (5A output for each) –

Only one of these wires need to be used (they are interchangeable) if the motorcycle or recreational vehicle) has a front running light. The wire should be connected to the (+) parking light wire.

Many motorcycles and recreational motorcycles do not have front running lights. If the motorcycle does not have front running light, you may want to use the separate left and right turn signal indicators for flash purposes. Connect one of the two White wires to right line of turn indicator and connect the other one to the left line indicator.

H1/2. Red / White wire – Turn Indicator Power Input –

The RED/WHITE wire is the input to the flashing turn indicator relay. The connection of the RED/WHITE wire will determine the output polarity of the flashing turn indicator relay.

If the motorcycle you are working on has +12volt switched turn indicators, you don't need connect this wire. This wire already connected to +12volt.

If the motorcycle's turn indicators are ground switched, cut the RED/WHITE wire, connect the RED/WHITE to chassis ground.

H1/4. Black wire -- System Ground –

This is main ground connection of the alarm module. Make this connection to a solid section of the vehicle frame. Do not connect this wire to any existing ground wires supplied by the factory wire loom, make the connection to the vehicle's frame directly.

H1/5. Brown wire – Positive Siren Drive Output (See Alarm Feature II – 1 Programming)

This is the positive (+) output connection for the siren. Current capacity is 2 Amp. Make connection to the (+) red wire from the siren. Make the (-) black wire coming from the siren to a good chassis ground.

H1/6. Red wire – System Power (+12V Constant) –

The Red wire supplies power to the system. Connect this wire to a constant +12 volt source.

H2. MINI CONNECTOR WIRE HARNESS:

H2/1. Orange wire – (-) 200mA Grounded Output When Armed –

This wire will become grounded when the alarm is armed. The current capacity of this wire is 200mA. This wire can be used to turn on an optional sensor or to ready an optional accessory.

H2/2. Green wire – Zone 3 / (-) Close Loop –

This wire can be used to protect a part of the motorcycle where a trigger is desired when the wires of the connection are not in contact, rather than in contact. This closed loop connection is useful for protecting things such as saddlebags, luggage carriers, etc. that could be easily removed from a motorcycle or other recreational vehicle. Connect this wire through the object being protected and then to the battery ground loop. Then, if the contact is broken on this wire when the alarm system is armed, the alarm will sound.

NOTE: When armed, the system checks to ensure that ground is present on this wire. If ground is not present on this wire, the system will ignore the zone (see Table of Zones section of this guide) and will not respond to the zone again until the system has been disarmed and rearmed.

H2/3. Pink wire – (-) 200mA Horn Output –

This wire is provided to use the existing motorcycle's horn as the alarm system's optional's warning audible device. It's a transistorized low current output, and should only be connected to the low current ground output from the motorcycle's horn switch. When the system is triggered, the horn will sound.

H2/4. Blue wire – Zone 2 / Ground Instant Trigger / Tilt Switch Input –

This wire is the ground trigger input wire. Connect this wire to one of the mercury tilt switches' wires. Connect the other tilt switch wire to battery ground. (These wires are interchangeable.) The mercury should only bridge the contacts if the motorcycle is tilted off its stand. A negative (-) input to this wire will cause an instant trigger, which will report on Zone 2.

H2/5. Violet wire – (-) 200mA Timer Control Channel 4 Output –(See Alarm Feature II – 3 Programming) (Factory default setting on momentary grounded)

This wire is built-in user-programmable timer output by activate **⏹** and **F** buttons on the transmitter at the same time. this output can be programmed to provide the following type of output: Momentary pulse / latched / Latched with ignition / 30 / 60 / 90 seconds timer control.

H2/6 . Gray wire – (-) 200mA Timer Control Channel 3 Output –(See Alarm Feature II – 2 Programming) (Factory default setting on 1 second pulse grounded)

This will become a 1 second pulse ground by activate **F** button on transmitter for two seconds, the current capacity of this wire is 200 mA. This output can be programmed to provide the following type of output: 1 second pulse / latched / Latched with ignition / 30 / 60 / 90 seconds timer control.

H2/7. Yellow wire – Zone 5 / To Ignition Switched +12V –

This wire is connected to a switched 12 volts source. This wire should receive "12 volts" when the ignition key is in the "ON" and "START" position. When the ignition is turned "OFF", this wire should receive "0" voltage.

H3. START KILL BLACK WIRES

- Find the wire from the starter solenoid, (usually located on the starter) and going to the ignition switch.
- When found, use voltmeter, connect one probe of the voltmeter to ground and connect the other end of the probe to the starter wire, it should receive "12 volts" only when the ignition key in the "START" position.
- After locating the correct wire, cut it in half, try to start the motorcycle. The engine should not "crank over".
- When the extend wires are needed, they must be exactly same gauge as the cut wire. Connect the cut wire to the one of Black wire, and connect the another cut wire to the other Black wire.

H4. RF ANTENNA - BLACK THIN WIRE

The black thin wire on control module is the receiver antenna wire. Antenna placement is very important! Ensure that it is unwrapped and stretched out with the last 6" straight and keep it away from large metal objects or chassis for best reception.

PROGRAMMING

A. PROGRAMMING TRANSMITTER:

Note: This mode will only retain the last 4 remote transmitters programmed. If the transmitter memory is exceeded, the security system will start deleting transmitters from memory in chronological order.

1. Turn the Ignition 'switch 'OFF/ON' 3 TIMES and stay in ON position. Within 15 seconds.
2. Push the Valet switch **3** times and holding in on **3rd** push until a long chirp is hearing then release the valet switch. You are now in the Transmitter programming mode.
3. Press and hold any button of the transmitter until the siren responds with a confirming chirp, indicating the signal has been stored into memory.
4. If you have additional transmitters (up to 4) that need to be programmed, repeat step 3 for each transmitter.

Exit: Turn Ignition to 'OFF' position, or leave it for 15 seconds. A 3 long chirps & 3 parking light flashes to confirm exit.

B. ALARM FEATURES PROGRAMMING:

ALARM FEATURE "I" PRORAMMING:

1. Turn the Ignition 'switch 'ON/OFF' 3 TIMES and stay in OFF position.
2. Push the Valet switch **2** times and holding in on **2nd** push until **one** chirp with a long chirp is hearing then release the valet switch. You are now in the Alarm feature 'I' programming mode.
3. Press and release the transmitter button 'A' corresponding to the feature 'A' you want to change.
 - a. The siren chirps and LED pause will indicate previously setting.
 - b. The system would advance to [2] LED flash, [2] chirp. (The factory default settings is always [1] LED flash, [1] chirp.)
4. Depress the transmitter button 'A' again to change the feature again. Simple keep re-depressing the transmitter button 'A' again until the module advances to your desired setting.
5. Depress the transmitter button 'B' corresponding to the feature 'B' you wants to program.

Press Transmitter Button	One Chirp / LED one pulse Factory Default Setting	Two Chirps / LED two pulses	Three Chirps / LED three pulses	Four Chirps / LED four pulses
1	All Chirps on	Siren Chirps on only	Horn Chirps on only	All Chirps off
2	Automatic Rearm on	Automatic Rearm off		
3	Active arming	Passive arming	Active arming with Passive starter disable	
4 +	Horn Chirp 10ms	Horn Chirp 16ms	Horn Chirp 20ms	

Exit: Turn Ignition to 'ON' position, or leave it for 15 seconds. A 3 long chirps to confirm exit.

Active Arming With Passive Starter Disables: The "Ground-when-armed output will go active 60 seconds after the ignition is turn off. The LED will flash at half its normal rate when the ignition is turn off to indicate that the system will interrupt the starter in 60 seconds.

ALARM FEATURE "II" PRORAMMING:

1. Turn the Ignition 'switch 'ON/OFF' 3 TIMES and stay in OFF position.
2. Push the Valet switch **4** times and holding in on the **4th** push until **two** chirps with a long chirp is hearing then release the valet switch. You are now in the Alarm feature 'II' programming mode.
3. Press and release the transmitter button 'A' corresponding to the feature 'A' you want to program.

Press Transmitter Button	One Chirp / LED one pulse Factory Default Setting	Two Chirps / LED two pulses	Three Chirps / LED three pulses	Four Chirps / LED four pulses
1	H1/5 Brown Wire = Constant Siren output	H1/5 Brown Wire = 5-second pulse Siren output	H1/5 Brown Wire = Random pulse Siren output	
2	H2/6 Gray Wire Channel 3 Output = 1 second pulse	H2/6 Gray Wire Channel 3 Output = Latch	H2/6 Gray Wire Channel 3 Output = Latch with Ignition	4 Chirps = 30-second 5 Chirps = 60-second 6 Chirps = 90-second
3	H2/5 Violet Wire Channel 4 Output = Momentary output	H2/5 Violet Wire Channel 4 Output = Latched output	H2/5 Violet Wire Channel 4 Output = Latch with Ignition	4 Chirps = 30-second 5 Chirps = 60-second 6 Chirps = 90-second

Exit: Turn Ignition to 'ON' position, or leave it for 15 seconds. A 3 long chirps to confirm exit.

Momentary output = The momentary output selection will output a negative signal from the Channel 4 output immediately when the channel 4 button is pressed and will continue until the button is release.

Latched output = The latched output selection will output a negative signal as soon as the Channel 3 (4) button is pressed and will continue until the button is pressed again.

Latched /Reset with ignition = A latched / reset with ignition output works similar to the latched output, but will also reset (output will stop) when the ignition is turned on then off.

30/ 60/ 90seconds timed output = A 30, 60, or 90-second timed output will send a signal for 30, 60, or 90 seconds, respectively, when the channel 3 / 4 transmitter button(s) is pressed.

ALARM FEATURE “III” PRORAMMING:

1. Turn the Ignition 'switch 'ON/OFF' 3 TIMES and stay in OFF position.
2. Push the Valet switch **6** times and holding in on the **6th** push until three chirps with a long chirp is hearing then release the valet switch. You are now in the Alarm feature 'IV' programming mode.
3. Press and release the transmitter button 'A' corresponding to the feature 'A' you want to program.

Press Transmitter Button	One Chirp / LED one pulse Factory Default Setting	Two Chirps / LED two pulses
1	Exit the programming mode. (3 long chirp to confirm this exit.)	
2	Override Without Password Pin Code (Press & hold button for 4 seconds to delete the Password pin code)	Override With Password Pin Code (Password pin code programming)
3	Adjust and Test the sensitivity level of the Shock Sensor. (Press & hold button for 2 seconds)	

Exit: Turn Ignition to 'ON' position, or leave it for 15 seconds. A 3 long chirps to confirm exit.

Password Pin Code Setup:

1. Turn the Ignition 'switch 'ON/OFF' 3 times and stay in OFF position.
2. Push the Valet switch **6** times and holding in on the **6th** push until **three** chirps with a long chirp is hearing then release the valet switch. You are now in the Alarm feature 'III' programming mode.
3. Press and release button on the transmitter once, [2] LED flash, [2] siren/horn chirp to indicate you are in features “Password Pin Code Programming mode”.
4. Within 15 seconds, begin to enter your selected number by pressing and releasing the valet Switch from 1 – 9 times.
5. Finish by turning the ignition switch to “ON” position.

If the new password code was accepted, the unit would report back the newly entered code, by flashing the LED, first indicating the first digit code has been memorized, pause and then the second digit code.

The unit will report the new code three times with a one-second pause between each code.

Note: If 15 seconds of inactivity expire, or button on the transmitter is press during of above steps, the unit will revert back to the last successfully stored code. A [3] long chirps to confirm exit. Will revert back to the last successfully stored code

Delete Password Pin Code / Override Without Password Pin Code (Factory default setting):

1. Turn the Ignition 'switch 'ON/OFF' 3 times and stay in OFF position.
2. Push the Valet switch **6** times and holding in on the **6th** push until **three** chirps with a long chirp is hearing then release the valet switch. You are now in the Alarm feature 'III' programming mode.
3. Within 15 seconds, press and hold button on the transmitter for 4 seconds. One chirps to confirm Deleted the Password Pin Code.



Adjust and Test the sensitivity level of the Shock Sensor

1. Turn the Ignition 'switch 'ON/OFF' 3 TIMES and stay in OFF position.
2. Push the Valet switch **6** times and holding in on the **6th** push until three chirps with a long chirp is hearing then release the valet switch. You are now in the Alarm feature 'III' programming mode.
3. Press and hold button on the transmitter for 2 seconds. [2] LED flash, [2] siren/horn chirps to indicates the unit is ready to accept adjustments of the shock sensor.
4. Press button on the transmitter once will decrease sensitivity level by one, each time an decrease is made the siren/horn chirp will respond with [1] chirp, while 2 chirp indicates the minimum of sensitivity.
5. Press button on the transmitter once will increase sensitivity level by one, each time an increase is made the siren/horn chirp will respond with [1] chirp, while 2 chirp indicates the maximum of sensitivity.
6. Hit the bumper or strong metal part of the motorcycle to test the threshold level of the sensor.
 - a). Activate the warn-away (first stage the shock sensor), the siren/horn will emit a short chirp.
 - b). Activate the full alarm (second stage the shock sensor), the siren/horn will emit a long chirp.

7. When you are satisfied with the setting, press the  button once time to lock in the adjustment.

Note: If 20 seconds of inactivity expire, or  button on the transmitter is press during of above steps, the unit will exit the program mode and return to the disarmed mode. A 3 long chirps to confirm exit.

Return To Factory Default Setting:

1. Turn the ignition ON then OFF 3 TIMES and stay in OFF position.
2. Push the Valet switch **12** times and holding in on the **12th** push until **six** chirps with a long chirp is hearing then release the valet switch. You are now in the "Return To Factory Default Setting" programming mode.
3. Press the  and  buttons at the same time on the transmitter together for 6 seconds, there will be a confirmation six chirp with 3 long chirp to confirm the system "Alarm Feature" all returns to factory default setting.

OPERATION:

A. TRANSMITTER OPERATION:

Transmitter Button	System Function	Remark
	Arm the System	Press and release momentarily
-	Arming with Noiseless Mode	Press button within 3 seconds after arming.
- -	Arming with Shock Sensor Bypass	Press button 2 times within 5 seconds after arming
-	Arming with Pathway Illumination	Press the button first within 3 seconds press
-	Silent Arm	Press the button first within 3 seconds press
+	Arming with Hidden Alarm	Press the and buttons together
	Car Locator	Upon armed
(3 seconds)	Panic	Press and Hold button for 3 seconds
	Disarm System	Press and release momentarily
-	Disarming with Pathway Illumination	Press the button first within 3 seconds press
-	Silent Disarm	Press the button first within 3 seconds press
-	Passive Arming By-pass	Upon disarmed, press the button twice within 3 seconds.
- -	Remote control Enter/Exit Valet mode	Press the button 3 times within 5 seconds.
(2 seconds)	Channel # 3 Timer Output	Press and Hold for 2 seconds
+ (2 seconds)	Channel # 4 Timer Output	Press the and buttons together
●	Switching code For 2nd Car Operation or Garage Door Opener	

B. LED INDICATORS:

LED	Function
Off	Disarmed
Slow Flash	Armed
Flash	Passive Start Disable
Fast Flash	Passive Arming
On (Solid)	Valet Mode

LED	Function
2 flashes... pause	Zone 2 / Activated on the Tilt Switch
3 flashes... pause	Zone 3 / Activated on the Close Loop
4 flashes... pause	Zone 4 / Activated on the Shock Sensor
5 flashes... pause	Zone 5 / Activated on the Ignition Switch

C. CHIRP INDICATORS:

Chirp	Function
1 chirp	Arm
2 chirps	Disarm
4 chirps	Disarm / Triggered
6 chirps	Car locator

D. PARKING LIGHT:



Parking light	Function
1 flash	Arm
2 flashes	Disarm
3 flashes	Disarm / Triggered
12 flashes	Car locator



E. SYSTEM OPERATING CONDITION:

	Siren, Horn	Parking Light	LED	Starter
1. Arming	1 Chirp	1 Flash	Slow Flash	Disable
2. Disarming	2 or 4 Chirps	2 or 3 Flashes	Fast Flash or Off	
3. Trigger	Alarming	Flashes	Slow Flash	Disable
4. Passive Starter Disable			Flash	Disable
5. Panic	Alarming	Flashes		
6. Car Locator	6 Chirps	12 Flashes		

F. ACTIVE ARMING:

1. Press  button on transmitter.
2. The siren will chirp once and the parking light will flash once indicating the system is armed. The LED will begin to flash and the engine starter will be disabled.

SILENT ARMING: Press the  button first, within 3 seconds press  button on the transmitter will arm your security system, No chirp sound will be heard, arm confirmation will be through the motorcycles parking lights only.

ARMING WITH NOISELESS MODE: With the system disarmed, press the  button once, the siren will chirp once. Within 3 seconds, press  button again. The siren will emit one short chirp indicating the system is set and will be fully armed in 5 seconds with the noiseless mode for one arming cycle. In this mode, whenever strong vibration or lesser vibration is presented to the protected motorcycle, the shock sensor cannot trigger the system and just only emit a few warn away chirps.



ARMING WITH SHOCK SENSOR BY-PASS: Press the  button on the transmitter three times within 5 seconds will arm the security system, by-pass the shock sensor. The system will chirp one additional time to confirm the sensor bypass mode was activated. The sensor bypass feature is programmed to activate for one arming cycle only. The security system will return to normal operation during the next arming cycle.



PASSIVE STARTER DISABLES: (See Feature I - 2 Programming)

The purpose of the feature is to protect the motorcycle from being stole at all times, regardless of whether or not the alarm is armed.

The starter of the vehicle will be disable 60 seconds after the ignition is turned off. Once the key is turned off, the LED will flash fast for 60 seconds.

After 60-second timer has elapsed, the LED will flash slowly (one-half its normal armed rate) to indicate the passive starter disable is activated and the system will not respond to any trigger input except the ignition trigger.



ARMING WITH PATHWAY ILLUMINATION: Press the  button once to arm the system, the siren will chirp once. Within 3 seconds, press  button. The parking light will be turns "ON" for 30 seconds to illuminate your pathway.

HIDDEN ALARM FUNCTION: Press  and  buttons at the same time the security system will arm and with "Hidden Alarm Function". The siren / horn will be silenced even if the sensor is triggered in the armed status.

G. PASSIVE ARMING (See Alarm Feature I – 3 Programming)



Active arming / disarming is controlling your security system via the remote transmitter. This security system is equipped with an optional Passive Arming feature, which allows the security system to arm 30 seconds after the ignition switch is turns off. Operation is as follows.

1. Turn the ignition to the "OFF" position.
2. The security system LED will flash fast for 30 seconds. Each time a sensor is triggered during the passive arming countdown, the 30-second countdown starts over.
3. After 30-second timer has elapsed, the security system will automatically "ARM". The siren will chirp [1] time and the parking lights will flash [1] time.

PASSIVE ARMING BY-PASS: While the system disarmed, press the  button twice within 3 seconds, the security will respond with [1] chirp and LED will turn "ON". The security system will remain in this temporarily state for as long as you wish. To exit passive by-pass, press the  button or  button and the system will return to normal status.

H. ACTIVE DISARMING

1. Press  button on the transmitter.
2. The siren will chirp twice and parking light will flash twice to indicating that the security system is now disarmed.

SILENT DISARMING: Press the  button first, within 3 seconds press  button to silent disarm your security system, No chirp sound will be heard, arm confirmation will be through the motorcycles parking lights only.

TAMPER DISARMING: If alarm triggered, upon disarm the system, siren chirp 4 times, parking light flash 3 times.

DISARMING WITH PATHWAY ILLUMINATION: Press the  button once to disarm the system, the siren will chirp once. Within 3 seconds, press  button. The parking light will be turns "ON" for 30 seconds to illuminate your pathway.

AUTOMATIC RE-ARM: If this feature is selected, the security system will automatically re-arm itself 60 seconds after disarming with remote transmitter. Press the  button twice within 3 seconds or turns on the ignition switch will cancel the rearm. (See Alarm Feature I – 2 Programming)

I. DISARMING WITHOUT A TRANSMITTER

OVERRIDE THE ALARM WITHOUT PASSWORD PIN CODE: (Factory Default Setting)

The Override function may be used if the remote transmitter is lost or inoperative.

1. Turn the ignition switch to 'ON' position. (Alarm will sound.)
2. Within 10 seconds push and release the valet switch

The alarm will stop sounding and enter the disarm mode. You can now start and operate the motorcycle normally.

OVERRIDE THE ALARM WITH PASSWORD PIN CODE: (See Alarm Feature III – 2 Programming)

Unlike valet switch easily found, and defeated, this security system allows the consumer to program a password pin code. Offering a higher level of security.

1. Turn the ignition switch to 'ON' position. (Alarm will sound.)
2. Press the Valet switch the selected number of times (1-9 presses) within 15 seconds.
(Press the Valet switch, system's siren will stop alarming, parking light will stop flashing, but the motorcycle cannot be start and drive away until you disarm the system.)

The system should now disarm. If it does not, you may have waited too long to press the Valet switch; turn the ignition off and on and try again.

J. VALET MODE: (System in Disarm or Valet mode)

The valet switch allows you to temporarily bypass all alarm function, eliminating the need to hand your transmitter to parking attendants or garage mechanics. When the system is in valet mode, all alarm function are bypassed, however the remote panic feature and Channel 3 /4 will remain operational. To use the valet mode, the system must first be disarmed either by using you remote transmitter, or by operating the Manual override sequence.

Enter Valet Mode:

1. From the disarmed condition, turn the ignition to "ON" position.
2. Push and hold valet switch for 2 seconds until the LED turns on. The LED will remain on as long as the system is in 'valet mode'.

Exit Valet Mode:

1. Return to normal operation, turn ignition 'on'.
2. Push and hold valet switch for 2 seconds, The LED will turn off indicate the system are exiting the valet mode.

REMOTE VALET: (System in Disarm or Valet mode)

Press and release the  button three times within 3 seconds to enter / exit valet mode.



A parking light flash to confirm enter valet mode

Two parking light flashing to confirm exit valet mode.

K. MOTORCYCLE LOCATOR:

Press the  button on the transmitter upon armed mode to active motorcycle locator function. The siren will chirp 6 times. The parking light will flash 12 times, for you to easily locate your motorcycle.

L. PANIC FUNCTION:

The transmitter can be used as a remote panic switch to manually trigger the alarm in case emergency. To activate the panic mode, press and hold  button of your transmitter for 3 seconds. The siren will sound and continue for 30 seconds or until  button is activated a second time.

M. TRIGGER THE SYSTEM

When armed, your motorcycle is protected as follows:

1. Light impacts will trigger the warn-away signal. A long chirp from siren/horn.
2. Heavy impacts will trigger the system. The full trigger sequence is 30 seconds of constant siren and flashing parking lights.
3. If the tilt switch is triggered / the close loop wires of the connection are not in contact / the ignition is turned on while the system is armed, the full trigger sequence will activate.
4. The starter kill prevents the motorcycle's starter from cranking.

NOISE ABATEMENT CIRCUIT: Your system has "Noise Abatement Circuit". It prevents annoying repetitive trigger sequences due to faulty sensor or environmental condition such as thunder, jackhammers airport noise, etc.

Here's how "Noise Abatement Circuit" works: The alarm triggers five times. Each time, the same sensor or switch is triggering the alarm. "Noise Abatement Circuit" will interpret this pattern of triggers as false alarm. After the fifth trigger, "Noise Abatement Circuit" ignores, or by pass, that sensor or switch until the other sensor or switch is trigger.

N. SYSTEM'S TRIGGER CHECK (For two-way transceiver operation only)

Press the transceiver SET button first, within 3 seconds press  (C) button. It responds with one melody sound and all trigger's records will immediately displayed on the LCD screen.



O. CHANNEL 3 TIMER CONTROL OUTPUT.

Press and hold the  button on transmitter for two seconds to remote control the channel 3 output. Channel 3 is user-programmable timer output. You may program the built-in timer to send a ground signal / latch / latch with ignition / 30 seconds/ 60 seconds/ 90 seconds timer output.

Note1: Factory default setting at 1second pulse grounded output (See Alarm Feature II – 2 Programming).

Note2: Upon activate the channel 3; the siren/horn will emit one chirp to indicator the channel 3 is latch on or emit two chirps to indicator the channel 3 is latch off.

P. CHANNEL 4 TIMER CONTROL OUTPUT

Press the transmitter  and  buttons at the same time to active Channel 4 function.

Channel 4 is user-programmable timer output. You may program the built-in timer to send a momentary / latch / latch with ignition / 30 seconds/ 60 seconds/ 90 seconds timer output.

Note1: Factory default setting at momentary output (See Alarm Feature II – 3 Programming).

Note2: Upon activate the channel 4; the siren/horn will emit one chirp to indicator the channel 4 is latch on or emit two chirps to indicator the channel 4 is latch off.

Q. POWER ON MEMONRY:

This security system is equipped with circuitry that will allow the unit to remember its alarm state if the power is lost and then reconnected.

R. SECOND VEHICLE OPERATION

Your 5-button remote transmitter can be utilized to control a 2nd vehicle keyless entry system. To program the remote control transmitter to a 2nd vehicle, follow the instruction for Transmitter programming. All programming parameters be the same except for the following:

1. Prior to pushing any buttons on the transmitter. Press the ● button 1st on the transmitter.
2. Once the ● is pressed the LED on the transmitter will illuminate for 3.5 sec. to indicate the 2nd transmitter pin code has built in.

S. 2-WAY UPGRADE:

This unit is capable of 2-way communication to notify the owner if anyone is trying to tamper with the vehicle or to confirm remote start operation. If you would like to upgrade this unit to a 2-way system by purchasing a 2-way LCD transceiver, please contact your authorized reseller.

This device complies with part 15 of the FCC rules. Operation is subject to the following two conditions.

- (1) This device may not cause harmful interference, and
- (2) This device must accept any interference received, including interference that may cause undesired operation.

