

MEGALARM®

MEGA 670L

DELUXE 4-CHANNEL
CAR ALARM SECURITY SYSTEM

Installation And Operation Manual



MEGATRONIX
CALIFORNIA, U.S.A.

WIRING DIAGRAM

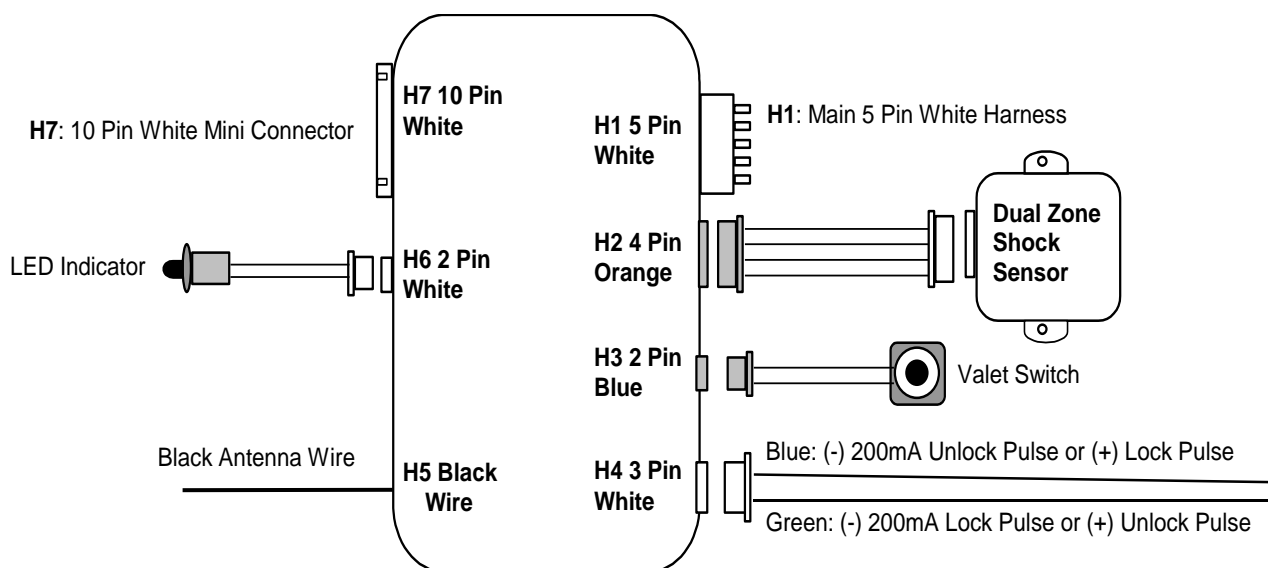

H1: MAIN 5 PIN WIRE HARNESS:

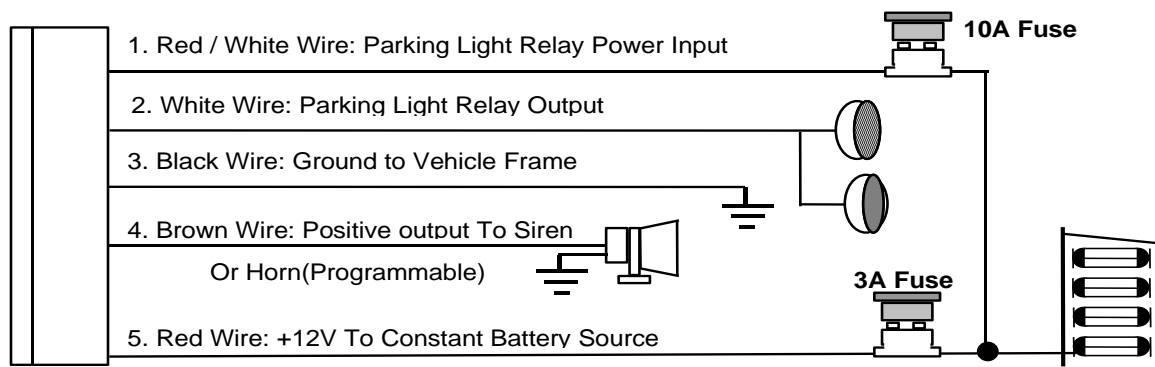

H7: 10 PIN MINI CONNECTOR WIRE HARNESS:

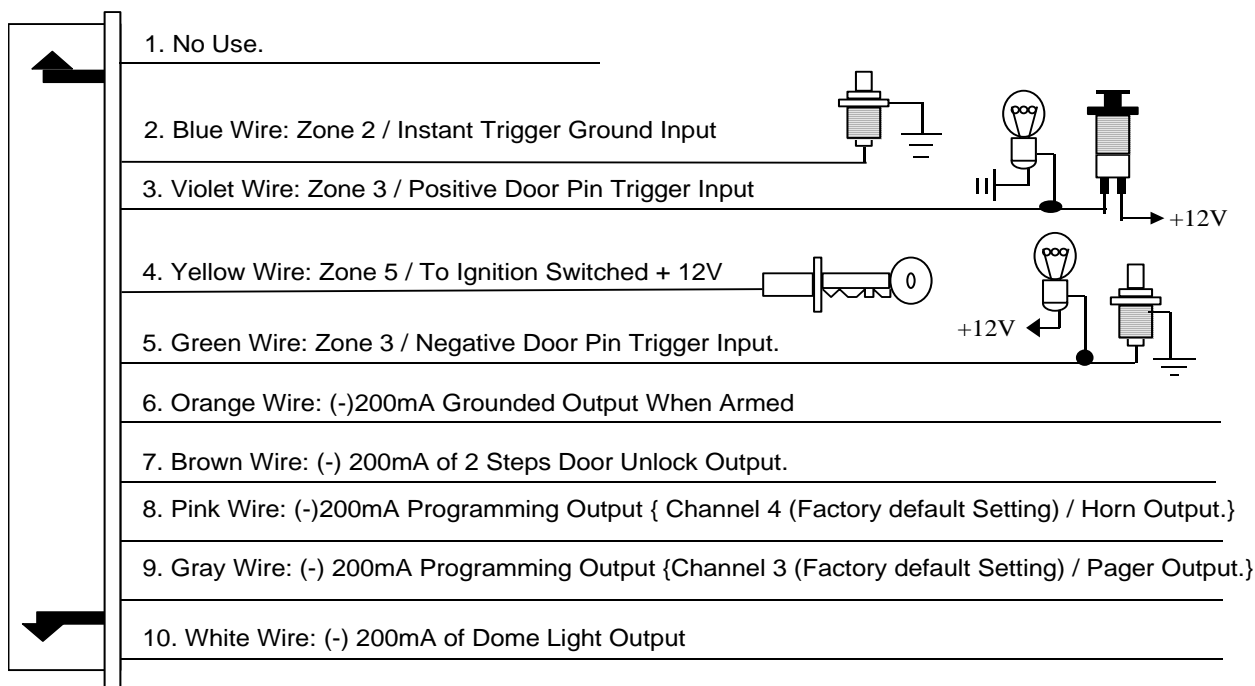

WIRING

Keep wiring away from moving engine parts, exhaust pipes, and high-tension cable. To prevent fraying, tape wires that pass through holes on the firewall. Watch out for sharp edges that may damage wires and cause short circuit.

CAUTION: Do not connect the wiring harness to the control module until all wiring to vehicle is complete.

H1: MAIN 5 PIN WIRE HARNESS:

H1/1. Red / White wire – Parking Light Relay Input –

The RED/WHITE wire is the input to the flashing parking light relay. The connection of the RED/WHITE wire will determine the output polarity of the flashing parking light relay.

If the vehicle you are working on has +12 volt switched parking light, you do not need to connect this wire.

This wire is already connected to +12 volt.

If the vehicles parking light is with a ground switched, cut the RED/WHITE wire, connect the RED/WHITE wire to chassis ground.

H1/2. White wire – Parking Light Relay Output (+12 V 10A Output) –

Connect the WHITE wire to the parking light wire coming from the headlight switch. Do not connect the WHITE wire to the dashboard lighting dimmer switch. (Damage to the dimmer will result). The limitation of the WHITE wire is 10 Amp max. Do not exceed this limit or damage to the alarm and parking relay will result.

H1/3. Black wire – System Ground –

This is main ground connection of the alarm module. Make this connection to a solid section of the vehicle frame. Do not connect this wire to any existing ground wires supplied by the factory wire loom. Make the connection to the vehicle's frame directly.

H1/4. Brown wire – Siren Drive or Horn Output – (Set Feature III – 1 Programming)

SIREN DRIVE OUTPUT (Factory default setting)

This is the positive (+) output connection for the siren. Current capacity is 2 Amp. Make connection to the (+) red wire from the siren. Make the (-) black wire coming from the siren to a good chassis ground.

(+) Low Current HORN OUTPUT -- (Set Alarm Feature III – 1 To Horn Output)

This wire is provided to use the existing vehicle's horn as the alarm system's optional warning audible device. It is a transistorized low current output, and should only be connected to the low current positive (+) output from the vehicle's horn switch.

H1/5. Red wire – System Power (+12V Constant) –

The RED wire supplies power to the system. Connect this wire to a constant +12 volt source.

H2. 4 PIN ORANGE CONNECTOR FOR 2 STAGE SHOCK SENSOR

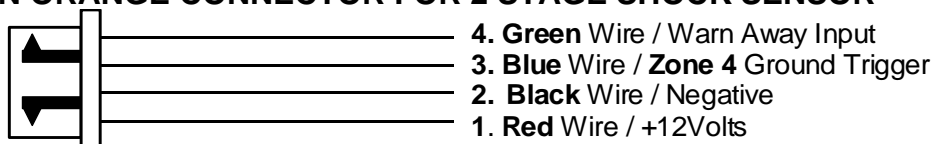

Route the red, black, blue and green wires in the 4 pin white connector from shock sensor to the control module, and plug one end into the shock sensor, and the other end into the mating orange connector on the side of the module.

H7: 10-PIN MINI CONNECTOR WIRE HARNESS.

H7/1. NO USE –

H7/2. Blue wire -- Ground Instant Trigger Input –

This wire is the ground trigger input wire for hood/trunk pin switches.

H7/3. Violet wire – Positive Door Switch Sensing Input –

This wire is the positive trigger input wire for positive door pin switch. This wire is the connection for "positive" type factory door pins (typically FORD). Locate the "common wire" for all door pins and make the connection of the Violet Wire here.

H7/4. Yellow wire – To Ignition Switched +12V –

This wire is connected to a switched 12 volts source. This wire should receive "12 volts" when the ignition key is in the "ON" and "START" position. When the ignition is turned "OFF", this wire should receive "0" volts.

H7/5. Green wire – Negative Door Switch Sensing Input –

This wire is the ground trigger input wire for negative door pin switch. This wire is the connection for "grounding" type factory door pins. Locate the "common wire" that connects the door pin switches. Make the connection of the GREEN Wire here.

H7/6. Orange wire – (-) 200mA Grounded Output When Armed –

This wire will become grounded when the alarm is armed. The current capacity of this wire is 200mA. This output can control a starter disable. When an intrusion is detected and the system is triggered, the vehicle is prevented from any unauthorized starting.

a). Find the wire from the starter solenoid, (usually located on the starter) and going to the ignition switch.

b). When found, use voltmeter, connect one probe of the voltmeter to ground and connect the other end of the probe to the starter wire, it should receive "12 volts" only when the ignition key in the "START" position.

- c). After locating the correct wire, cut it in half, try to start the vehicle. The engine should not "crank over".
 - d). When the extend wires are needed, they must be exactly same gauge as the cut wire. Connect the cut wire from the key switch to the RED wire (pin #30) of the relay, and connect the starter wire to the WHITE wire (pin #87a) of the relay.
 - e). Connect the ORANGE Wire from the control module to the ORANGE wire (pin #86) of the relay.
 - f). Connect the Yellow wire (pin #85) of the relay to a switched 12 volts source from the ignition switch.
- NOTE: If more than one electronic device will be connected to the ORANGE Wire, it will be necessary to isolate the connection of each device control wires with a 1N4003 diode.

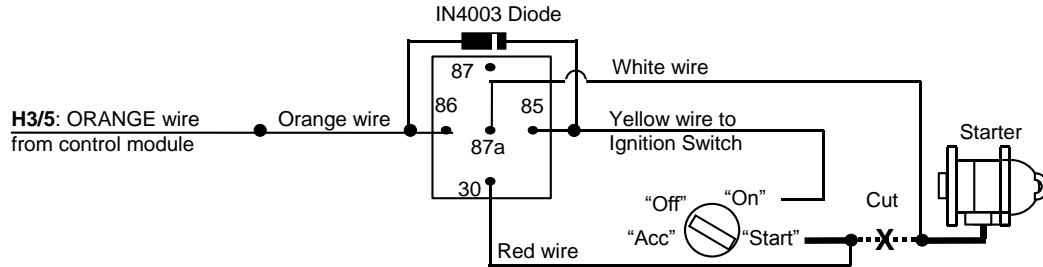

H7/7. Brown wire – (-) 200mA 2 Step Unlock Output –

The 2 step unlock feature will work for the most fully electronic door lock circuit. The vehicle must have an electronic door lock switch (not the lock knob or key switch), which locks and unlocks all of vehicle's doors. When wired for this feature, press the button one time to disarm the alarm and unlock the driver's door only. If, press button two times within 3 seconds, the alarm will disarm and all doors will unlock.

H7/8. Pink wire – (-) 200mA Programmable Output – CHANNEL 4 OUTPUT (Factory default setting)

This will become activated by press and hold button on the transmitter for two seconds. The current capacity of this wire is 200 mA. This feature allows you to remotely control the trunk release or another electric device.

HORN OUTPUT (Set Alarm Feature III – 5 To Horn Output)

This wire is provided to use the existing vehicle's horn as the alarm system's optional warning audible device. It is a transistorized low current output, and should only be connected to the negative (-) output from the vehicle's horn switch.

H7/9. Gray wire – (-) 200mA Programmable Output – CHANNEL 3 OUTPUT (Factory default setting)

This will become activated by press and hold button on the transmitter for two seconds. The current capacity of this wire is 200 mA. This feature allows you to remotely control the trunk release or another electric device.

PAGER OUTPUT (Set Feature III – 3 Programming to "PAGER Output)

This wire provides a negative output, when the alarm is triggered. The current capacity of this wire is 200mA. For optional electronic device in this system, please connect to an additional relay. (i.e. Pager interface)

H7/10. White wire – (-) 200mA Dome Light Control Output –

This wire becomes grounded when the dome light control circuit is active. The current capacity of this wire is 200mA. This wire can control the operation of the interior lights. An optional 10 Amp relay can be used on this system for interior lights operation.

- a). Upon disarming, the interior lights will remain on for 30 seconds.
- b). If the vehicle is violated, the interior lights will flash for the same duration as the siren.

H5: RF ANTENNA - BLACK THIN WIRE (DO NOT CUT!!!)

The black thin wire on control module is the receiver antenna wire. **Antenna placement is very important!** Ensure that it is unwrapped and stretched out with the last 6" straight and keep it away from large metal objects or chassis for best reception.

H4: 3 PIN DOOR LOCK CONNECTOR:

3 Pin Mini-Molex Connector

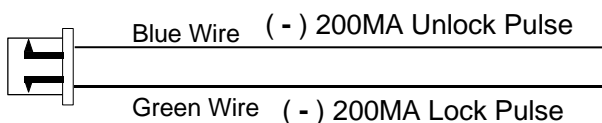

INSTALL NEW DOOR LOCK MOTOR

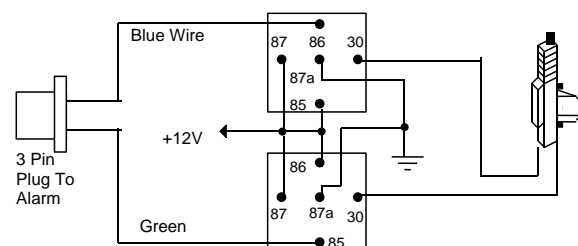

NEGATIVE TRIGGER DOOR LOCK SYSTEM

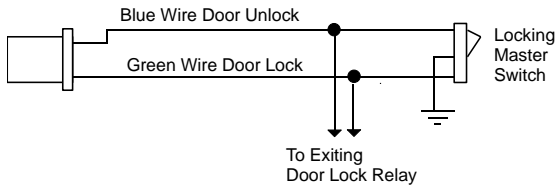

POSITIVE TRIGGER DOOR LOCK SYSTEM

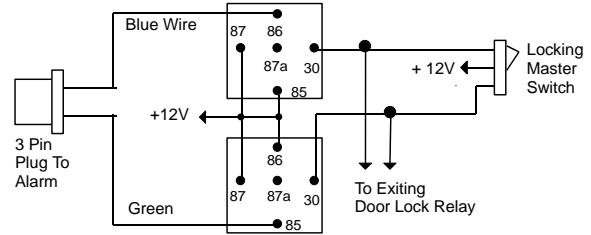

5-WIRE ALTERNATING DOOR LOCK

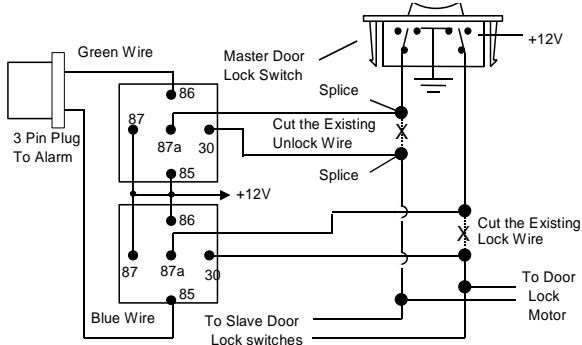

VACUUM OPERATED CENTROL LOCKING

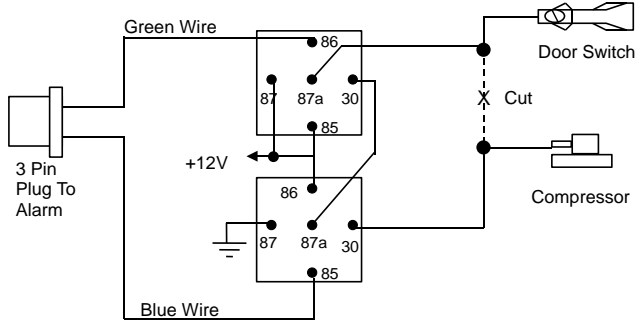

2 STEP DOOR UNLOCK WIRE CONNECTION FOR 5 WIRE ALTERNATING DOOR LOCKS

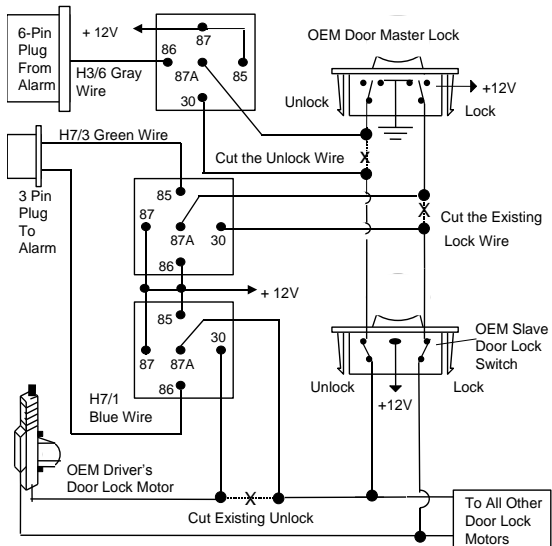

VACUUM OPERATED DOOR LOCKING SYSTEM: (TYPICAL OF MERCEDES BENZ AND AUDI)

Locate the wire under the driver's kick panel. Use the voltmeter connecting to ground, verify that you have the correct wire with the doors unlocked, the voltmeter receive "12 volts". Lock the doors and the voltmeter will read "0 volt". Move the alligator clip to +12V and the voltmeter will receive "12 volts". Cut this wire and make connections. Be sure to program door lock timer to 3 seconds (See Feature II – 1 Programming).

2 STEP DOOR UNLOCK WIRE CONNECTION FOR GROUND SWITCHED DOOR LOCKS

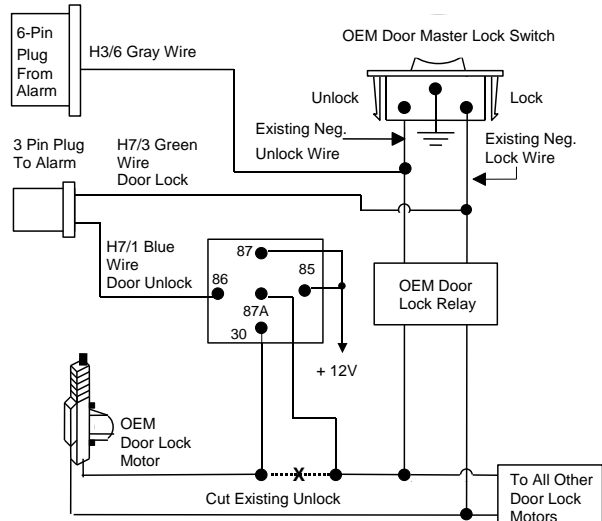

2 STEP DOOR UNLOCK WIRE CONNECTION FOR POSITIVE SWITCHED DOOR LOCKS

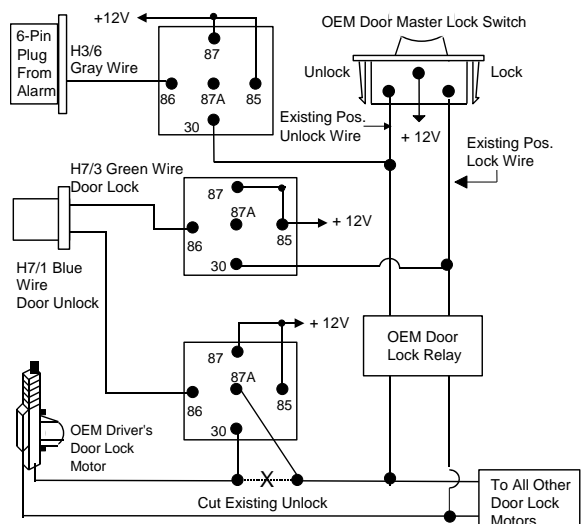

PROGRAMMING

A. THE TRANSMITTERS:

Enter:

1. Turn the Ignition 'switch 'OFF/ON' 3 TIMES and stay in ON position. Within 15 seconds.
2. Push the Valet switch 3 times and hold it until a long chirp is hearing then release the valet switch. You are now in the Transmitter programming mode.

Program:

1. Press button on one of the transmitter until the siren responds with a confirming chirp the first transmitter is now programmed.
2. Press button on the second transmitter until the siren responds with a confirming chirp, the second transmitter is now programmed.
3. Apply the same procedure to program 3rd and 4th

Exit: Turn Ignition to 'OFF' position, or leave it for 15 seconds. A 3 long chirps to confirm exit.

Note: If more than 4 transmitters programmed, the system only kept the last 4 transmitters.

B. ALARM FEATURES PROGRAMMING:

ALARM FEATURE "I" PRORAMMING:

1. Turn the Ignition 'switch 'ON/OFF' 3 TIMES and stay in OFF position.
2. Push the Valet switch **2** times and hold it until **one** chirp with a long chirp is hearing then release the valet switch. You are now in the Alarm feature 'I' programming mode.
3. Press and release the transmitter button 'A' corresponding to the feature 'A' you want to program.
 - a. The siren chirps and LED pause will indicate newly setting.
 - b. The system would advance to [2] LED flash, [2] chirp. (The factory default settings are always [1] LED flash, [1] chirp.)
4. Depress the transmitter button 'A' again to change the feature again. Simple keep re-depressing the transmitter button 'A' again until the module advances to your desired setting.
5. Depress the transmitter button 'B' corresponding to the feature 'B' you wants to program.

Press Transmitter Button	One Chirp / LED one pulse Factory Default Setting	Two Chirps / LED two pulses	Three Chirps / LED three pulses	Four Chirps / LED four pulses
1	All Chirps on	Siren Chirps on only	Horn Chirps on only	All Chirps off
2	Automatic Rearm on	Automatic Rearm off		
3	3 seconds Delay Door Ajar error chirp	30 seconds Delay Door Ajar error chirp.		
4 *	Without Anti Car-jack mode	Active Anti Car-jack mode	Passive Anti Car-jack mode	

Exit: Turn Ignition to 'ON' position, or leave it for 15 seconds. A 3 long chirps to confirm exit.

ALARM FEATURE "II" PRORAMMING:

1. Turn the Ignition 'switch 'ON/OFF' 3 TIMES and stay in OFF position.
2. Push the Valet switch **4** times and hold it until **two** chirps with a long chirp is hearing then release the valet switch. You are now in the Alarm feature 'II' programming mode.
3. Press and release the transmitter button 'A' corresponding to the feature 'A' you want to program.

Press Transmitter Button	One Chirp / LED one pulse Factory Default Setting	Two Chirps / LED two pulses	Three Chirps / LED three pulses	Four Chirps / LED four pulses
1	0.8-second Door lock pulses.	3.5-second Door lock pulse.	Double pulse unlock	
2	Active arming	Passive arming without passive door locking	Passive arming with passive door locking.	
3	Ignition controlled door locks	Without ignition controlled door locks		
4 +	Ignition controlled door unlocks	Without ignition controlled door unlocks		

5 *	Pathway illumination feature "off"	Parking light "on" for 30- second upon an unlock signal	Parking light "on" for 30- second upon an unlock signal & 10-second upon a lock signal.	
-----	------------------------------------	---	---	--

Exit: Turn Ignition to 'ON' position, or leave it for 15 seconds. A 3 long chirps to confirm exit.

ALARM FEATURE "III" PRORAMMING:

- 1 Turn the Ignition 'switch 'ON/OFF' 3 TIMES and stay in OFF position.
- 2 Push the Valet switch 6 times and hold it until three chirps with a long chirp is hearing then release the valet switch. You are now in the Alarm feature 'III' programming mode.
- 3 Press and release the transmitter button 'A' corresponding to the feature 'A' you want to program.

Press Transmitter Button	One Chirp / LED one pulse Factory Default Setting	Two Chirps / LED two pulses	Three Chirps / LED three pulses	Four Chirps / LED four pulses
1				
2	H1/4 Brown Wire = Constant Siren output for 6-tone siren	H1/4 Brown Wire = 5-second pulse Siren output for signal tone siren	H1/4 Brown Wire = Random pulse Siren output	H1/4 Brown Wire = Horn pulse Output
3	H7/9 Gray Wire Channel 3 Output = 1 second pulse output for trunk release.	H7/9 Gray Wire Channel 3 Output = Latch output	H7/9 Gray Wire Channel 3 Output = Timer controlled output	H7/9 Gray Wire = Pager output
4 *	* Button = PANIC Function.	* Button = Channel 4 Function.		
5	H7/8 Pink Wire Channel 4 Output = Momentary output	H7/8 Pink Wire Channel 4 Output = Latched output	H7/8 Pink Wire Channel 4 Output = Timer programming (set to any interval between 1 second and 2 minutes.)	H7/8 Pink Wire = Horn output

Exit: Turn Ignition to 'ON' position, or leave it for 15 seconds. A 3 long chirps to confirm exit.

Channel 3 (4) Timer Control Output Programming

Enter:

1. Turn the Ignition 'switch 'ON/OFF' 3 TIMES and stay in OFF position.
2. Push the Valet switch **6** times and hold it until **three** chirps with a long chirp is hearing then release the valet switch. You are now in the Alarm feature 'III' programming mode.

Timer Program:

- 1-a. Press and release the transmitter button 2 times, [3] LED flash, [3] siren/horn chirp to indicate you are in features "Channel 3 Timer Programming mode".
- 1-b. Press and release the transmitter button 2 times, [3] LED flash, [3] siren/horn chirp to indicate you are in features "Channel 4 Timer Programming mode".
2. Press and hold the valet switch, the timer will immediately start.
3. When the desired interval has passed, release the valet switch. 1 long chirp for confirmation. (Set to any interval between 1 second and 2 minutes)

Note 1:

If your built-in timer controls window/sunroof closure in your car DO NOT change the timer setting! This requires installer-only programming. Changing the value will adversely effect operation and may cause damage.

Note 2:







Momentary output = The momentary output selection will output a negative signal from the Channel 4 output immediately when the channel 4 button is pressed and will continue until the button is release.

Latched output = The latched output selection will output a negative signal as soon as the Channel 3 (4) button is pressed and will continue until the button is pressed again.

ALARM FEATURE "IV" PRORAMMING:

- 1 Turn the Ignition 'switch 'ON/OFF' 3 TIMES and stay in OFF position.

- 2 Push the Valet switch 8 times and hold it until four chirps with a long chirp is hearing then release the valet switch. You are now in the Alarm feature 'IV' programming mode.
- 3 Press and release the transmitter button 'A' corresponding to the feature 'A' you want to program.

Press Transmitter Button	One Chirp / LED one pulse Factory Default Setting	Two Chirps / LED two pulses	Three Chirps / LED three pulses
1 	Exit the programming mode. (3 long chirp to confirm this exit.)		
2. 	Press & hold  button for 4 seconds to delete the sensor code	Wireless door / window sensor & PIR sensor programming mode	
3 	Override Without Password Pin Code / Press & hold  button for 4 seconds to delete the Password pin code	Override With Password Pin Code / Password pin code programming	
4 * 	"TEST" Mode for Zone 2 Hood & Zone 3 Door Pin Switch	"TEST" Mode for Zone 4 / the Optional Sensor connected to 4 pin plug.	"TEST" Mode for Zone 1 / Wireless door/window sensor & PIR sensor

Exit: Turn Ignition to 'ON' position, or leave it for 15 seconds. A 3 long chirps to confirm exit.

Program The Wireless PIR Sensor or Wireless Door/Window Sensor.

This system has a very unique interfacing with optional sensor, to extend more protection, such as PIR (IR-70S) sensor or Door/Window sensor. (DS-70S)

For example, in your garage you can put a PIR for protection. (A device to detect person's movement in a protected area.) If system armed, a person walk through the detect area, the siren inside the car will alarming to raise the attention to the owner.

So the same thing applies in door/window sensor, (A device to detect door/window open.) you may put the sensor to the garage door or window. If system armed, a person opens the door or window, the siren will alarm. Set the PIR and door/window sensor the same code if you use both of them.

Enter:

4. Turn the Ignition 'switch 'ON/OFF' 3 TIMES and stay in OFF position.
5. Push the Valet switch **8** times and hold it until **four** chirps with a long chirp is hearing then release the valet switch. You are now in the Alarm feature 'IV' programming mode.

Program:

1. Press and release the transmitter  button once, [2] LED flash, [2] siren/horn chirp to indicate you are in features "Sensor Programming mode".
2. Activate the sensor to let the system program it's code. [2] Chirps to confirm programmed.
3. (Only one code could be program)

Delete:

Within 15 seconds, Again press and hold the transmitter  button for 4 seconds. A [1] long chirps to confirm deleted the sensor code.

Password Pin Code Setup:

Enter:

1. Turn the Ignition 'switch 'ON/OFF' 3 times and stay in OFF position.
2. Push the Valet switch **8** times and hold it until **four** chirps with a long chirp is hearing then release the valet switch. You are now in the Alarm feature 'IV' programming mode. You can program or delete the password pin code as below:

Program:

1. Press and release the transmitter  button once, [2] LED flash, [2] siren/horn chirp to indicate you are in features "Password Pin Code Programming mode".
2. Within 5 seconds, begin to enter your chosen first 9ths digit by pressing and releasing the valet Switch from 1 – 9 times.
3. Within 15 seconds of the last entered 10ths digit, turn the Ignition switch to "ON" position.
4. Within 15 seconds, enter your chosen second 10ths digit by pressing and releasing the valet Switch from 1 – 9 times.
5. Finish by turning the ignition switch to "OFF" position.

If the new password code was accepted, the unit would report back the newly entered code, by flashing the LED, first indicating the first digit code has been memorized, pause and then the second digit code. The unit will report the new code three times with a one-second pause between each code.

Note: If 15 seconds of inactivity expire, or if the ignition switch is turned "ON" for more then 5 seconds during of

above steps, the unit will revert back to the last successfully stored code. A [3] long chirps to confirm exit. Will revert back to the last successfully stored code

Delete Password Pin Code / Override Without Password Pin Code (Factory default setting):

Within 15 seconds, press and hold the transmitter  button for 4 seconds. A one chirps to confirm Deleted the Password Pin Code.

Example: To program the Password Code 92, you would;

Enter:

1. Turn the Ignition 'switch 'ON/OFF' 3 times and stay in OFF position.
2. Push the Valet switch **8** times and hold it until **four** chirps with a long chirp is hearing then release the valet switch. You are now in the Alarm feature '**IV**' programming mode.

Program:

1. Press and release the transmitter  button once, [2] LED flash, [2] siren/horn chirp to indicate you are in features "Password pin code programming mode".
2. Within 5 seconds, press and release the valet Switch 9 times.
3. Within 15 seconds of the last entered 10ths digit, Turn the Ignition Switch to "ON" position.
4. Within 15 seconds press the valet Switch twice.
5. Turn the Ignition Switch to "OFF" position.

You will note the LED flashing nine times, pause and then flash two times, pause. This pattern will be repeated three times indicating the new code (92) has been accepted and stored in memory.

Test Mode

In this test mode, this system can test the Zone 1 Wireless PIR or Door switch / Zone 2 Instant ground trigger / Zone 3 Door trigger and the Zone 4 optional sensor sensitivity. The installer can save time to test the optional sensor sensitivity and sensor without using the traditional arming/disarming procedures to test the sensors.

Enter:

1. Turn the Ignition 'switch 'ON/OFF' 3 TIMES and stay in OFF position.
2. Push the Valet switch **8** times and hold it until **four** chirps with a long chirp is hearing then release the valet switch. You are now in the Alarm feature '**IV**' programming mode.

4-a. Test the Zone 2 Instant Ground Trigger & Zone 3 Door Trigger:

Press and release the transmitter  button once. [1] LED flash, [1] siren/horn chirp to indicate you are in Zone 2 / instant ground trigger and Zone 3 / Door trigger test mode.

Trigger sensor	Siren chirps
Zone 2 / Instant Ground trigger (H7/2 Blue wire)	2
Zone 3 / Door trigger (H7/3 Violet & H7/5 Green Wire)	3

4-b. Test the Zone 4 / Optional Sensor (Connected to H2 4 Pin Plug):

Press and release the transmitter  button again. [2] LED flash, [2] siren/horn chirps to indicate you are in optional sensor (connected to H2 4 pin plug) test mode.



1. Activate the warn-away (first stage optional sensor), system will emit a short chirp.
2. Activate the full alarm (second stage optional sensor), system will emit a long chirp.
3. Continue to test the optional sensor until reach the proper sensitivity.

4-c. Test the Zone 1 / Wireless PIR or Door Switch:

Press and release the transmitter  button again. [3] LED flash, [3] siren/horn chirps to indicate you are in optional wireless PIR or Door switch test mode.

Trigger sensor	Siren chirps
Zone 1 / Optional wireless PIR or Door Switch	1

Return To Factory Default Setting:

1. Turn the ignition ON then OFF 3 TIMES and stay in OFF position.
2. Push the Valet switch **12** times and hold it until **six** chirp with a long chirp is hearing then release the valet switch. You are now in the "Return To Factory Default Setting" programming mode.
3. Press the  +  button on the transmitter together for 6 seconds, there will be a confirmation six chirp with 3 long chirp to confirm the system "Alarm Feature I & II & III & IV Programming all returns to factory default setting.

Exit: Turn the ignition switch "on" or leave it for 15 seconds. A 3 long chirps to confirm exit.

OPERATION:

A. TRANSMITTER OPERATION:

Transmitter Button	System Function	Remark
	Lock Doors & Arm System	
	Arm and Delete The Zone 4 / Shock Sensor	Press twice within 3 seconds.
	Unlock Doors & Disarm System	
	Disarm & Channel 3 (Trunk) Timer Control	Press and Hold for 2 seconds
	Two Steps Door Unlock & Disarm System	Press twice within 3 seconds.
	Silent Arming / Disarming	Ignition in "off" position.
	Activate Car-Jacking	Ignition in 'on' position and Press and Hold for two seconds
	Channel 3 (Trunk) Timer Control	Press and Hold for 2 seconds
	Passive Arming By-pass	While the system disarmed.
	Switching code For 2nd Car Operation or Garage Door Opener	

* Button = Panic Function. (Factory Default Setting)

	Channel 4 Timer Control	
	Car Locator	
	Panic function	Press and Hold for 3 seconds
	Panic Function	Press and Hold for 3 seconds.

* Button = Channel 4 Function. (See Feature III – 4 Programming)

	Panic Function	Press and Hold for 3 seconds.
	Car Locator	While the system in Armed
	Channel 4 Timer Control	

Second Vehicle Transmitter Programming:

Your 5-button remote transmitter can be utilized to control a second vehicle security system. To program the remote control transmitter to a second vehicle, follow the instructions for Transmitter programming. All programming parameters are the same except for the following:

1. Prior to pushing any button on the transmitter. Press the **Side Button** first on the transmitter.
2. Once **Side Button** is pressed the LED on the transmitter will illuminate for 3.5 seconds.
3. While the LED is illuminated, press any button on the remote control transmitter.

B.LED INDICATORS:

LED	Status
Off	Disarmed
Slow flash	Armed
Fast flash	Passive arming
On (solid)	Valet mode

LED	Status
1 flashes... pause	Zone 1 / Trigger on PIR or Door Sensor
2 flashes... pause	Zone 2 / Trigger on Trunk/Hood
3 flashes... pause	Zone 3 / Trigger on Door Switch
4 flashes... pause	Zone 4 / Trigger on Shock Sensor
5 flashes... pause	Zone 5 / Trigger on Ignition Switch

C. CHIRP INDICATORS:

Chirp	Function
1 chirp	Arm
2 chirps	Disarm
3 chirps	Defective reminder
4 chirps	Disarm / Triggered
6 chirps	Car locator

D. PARKING LIGHT:

Parking light	Function
1 flash	Arm
2 flashes	Disarm
3 flashes	Disarm / Triggered
12 flashes	Car locator

E. SYSTEM OPERATING CONDITION:

	Siren, Horn	Parking Light	LED	Doors	Starter	Dome Light	Pager
1. Arming	1 or 3 Chirps	1 Flash	Slow Flash	Locking	Disable		
2. Disarming	2 or 4 Chirps	2 or 3 Flashes	Fast Flash or Off	Unlocking		Turns on for 30 -second	

3. Trigger	Alarming	Flashes	Slow Flash		Disable	Flashes	On
4. Panic	Alarming	Flashes				Flashes	
5. Car-Jacking	Alarming	Flashes			Disable	Flashes	
6. Car Locator	6 Chirps	12 Flashes					

F. ACTIVE ARMING – LOCK & ARM:

1. Press  button on transmitter.
2. The siren will chirp once and parking light will flash once indicating that the system is now armed. The vehicle doors will lock upon arming when interfaced with the security system.

Note: The wireless PIR sensor and wireless door/window sensor is delay trigger, it will arm after 30 seconds.

DEFECTIVE SENSOR REMINDER: If the siren sounds 3 chirps, then you have left a door, trunk, or hood lid ajar. (See Feature “I - 3 Programming)

SILENT ARMING / DISARMING: Press the  +  button together on the transmitter will arm or disarm your security system, No chirp sound will be heard, arm / disarm confirmation will be through the vehicles parking lights only.

SHOCK SENSOR / OPTIONAL SENSOR BY-PASS: Press the  button on the transmitter twice within 3 seconds will arm the security system, by-pass the shock sensor and the optional sensor connected to 4 pin plug. The system will chirp one additional time to confirm the sensor bypass mode was activated. The sensor bypass feature is programmed to activate for one arming cycle only. The security system will return to normal operation during the next arming cycle.



G. PASSIVE ARMING (See Feature “II - 2” Programming)

Active arming / disarming is controlling your security system via the remote transmitter. This security system is equipped with an optional Passive Arming feature, which allows the security system to arm 30 seconds after the last door is closed. Operation is as follows.

1. Turn the ignition to the “OFF” position and exit the vehicle.
2. After all entrances are closed, the security system LED will flash fast for 30 seconds. If you reopen any door / hood / trunk, the security system LED will stop flashing. It will begin flashing again once the vehicle all entrances are closed.
3. After 30-second timer has elapsed, the security system will automatically “ARM”. The siren will chirp [1] time and the parking lights will flash [1] time.

PASSIVE DOOR LOCKING: (See Feature “II - 2” Programming)

The vehicle doors will automatically lock after passive arming cycle has been completed.

PASSIVE ARMING BY-PASS: While the system disarmed, press the  button twice, the security will respond with [1] chirp and LED will turn “ON”. The security system will remain in this temporarily state for as long as you wish. To exit passive by-pass, press the  or  button and the system will return to normal status.

H. ACTIVE DISARMING – UNLOCK & DISARM:

1. Press  button on the transmitter.
2. The siren will chirp twice and parking light will flash twice to indicating that the security system is now disarmed. The vehicle doors will unlock and dome light will turn on for 30 seconds upon disarming when interfaced with the security system.

TAMPER DISARMING: If alarm triggered, upon disarm the system, siren chirp 4 times, parking light flash 3 times.

PATHWAY ILLUMINATION (See Alarm Feature “II - 5” Programming): This feature turns the parking light “ON” for 30 seconds upon a unlock signal and for 10 seconds upon the lock signal.

TWO STEP DOOR UNLOCK: This feature will independently unlock the driver's door only when disarming the security system. Pushing the  button on the transmitter a second time within 3 seconds will unlock the entire vehicle.

AUTOMATIC RE-ARM (See Feature “I - 2” Programming): If this feature is selected, the security system will automatically re-arm itself 60 seconds after disarming with remote transmitter. Automatic rearm will cancel if any door is opened before the 60 seconds timer has elapsed.

I. DISARMING WITHOUT A TRANSMITTER

OVERRIDE THE ALARM WITHOUT PASSWORD PIN CODE: (Factory Default Setting)

The Override function may be used if the remote transmitter is lost or inoperative.

1. Enter the vehicle and turn the ignition switch to 'ON' position. (Alarm will sound.)
2. Within 10 seconds push and release the valet switch

The alarm will stop sounding and enter the disarm mode. You can now start and operate the vehicle normally.

OVERRIDE THE ALARM WITH PASSWORD PIN CODE: (Alarm Feature IV - 3 Programming)

Unlike valet switch easily found, and defeated, this security system allows the consumer to program a password pin code. Offering a higher level of security.

1. Enter the vehicle and turn the ignition switch to 'ON' position. (Alarm will sound.)
 2. Within 5 seconds, enter your chosen first 10ths digit by press and release the Valet Switch. (When finished above procedures, system's siren stop alarming, parking light stop flashing, other sensor stop trigger, but the vehicle can not be start and drive away.)
 3. Within 15 seconds of the last entered 10ths digit, turn the Ignition Switch "OFF" then "ON".
 4. Within 15 seconds, enter your chosen second 10ths digit by press and release the Valet Switch.
 5. Turn the ignition switch "OFF" position.
- [4] Chirps form siren/horn, [3] flash from parking light and LED will turn off to indicate the system was disarmed.

Note 1: You must override the alarm within 60 seconds. If not, the system will automatically re-arm.

EXAMPLE: To Override The System With The Password Code 83, you would;

1. Enter the vehicle and turn the ignition switch to 'ON' position. (Alarm will sound.)
 2. Within 5 seconds, Press and Release the Valet Switch 8 times (When finished above procedures, system's siren stops alarming, parking light stop flashing, other sensor stop trigger, but the vehicle can not be start and drive away.)
 3. Within 15 seconds of the last entered 10ths digit, turn the Ignition Switch "Off" then "ON".
 4. Within 15 seconds, Press and Release the Valet Switch 3 times
 5. Turn the Ignition Switch to "Off" position.
- [4] Chirps form siren/horn, [3] flash from parking light and LED will turn off to indicate the system was disarmed.

J. VALET MODE: (System in Disarm or Valet mode)

The valet switch allows you to temporarily bypass all alarm function, eliminating the need to hand your transmitter to parking attendants or garage mechanics. When the system is in valet mode, all alarm function are bypassed, however the remote panic feature and remote door locks will remain operational. To use the valet mode, the system must first be disarmed either by using you remote transmitter, or by operating the Manual override sequence.

Enter Valet Mode: 1. Turn the ignition to "ON" position.
2. Push and hold valet switch for 2 seconds until the LED turns on. The LED will remain on as long as the system is in 'valet mode'.

Exit Valet Mode: 1. Return to normal operation, turn ignition 'ON'.
2. Push and hold valet switch for 2 seconds, The LED will turn off indicate the system are exiting the valet mode.

K. CAR LOCATOR (See Feature III – 4 Programming)







Press the * button on the transmitter to active car locator function. ((Factory Default setting)

Under Armed mode, press the  button on the transmitter to active car locator function. (If you Program * button = Channel 4 Function)

The siren will chirp 6 times. The parking light will flash 12 times, for you to easily locate your car.

L. PANIC FUNCTION: (See Feature III – 4 Programming)

The transmitter can be used as a remote panic switch to manually trigger the alarm in case emergency.

1. Press and hold the  button or * button on the transmitter for 3 second. The alarm will immediately sound. (Factory Default setting)
2. During panic mode, the normal function of this transmitter button will be suspended. The  and  buttons can be used to lock and unlock the doors (if the option is installed), however once the  button is pressed, the vehicle's starter disable device, (where installed) will be enable allowing the vehicle to start.
3. To stop the alarm, press and hold the * or  button on the transmitter again for 3 seconds. Also if any transmitter button other than the * or  button is pressed and released, the panic mode will be turned off immediately.
4. If the button is not pressed, the alarm will automatically stop after 60 seconds.

M. TRIGGER THE SYSTEM

When armed, your vehicle is protected as follows:

1. Light impacts will trigger the warn-away signal. A long chirp from siren/horn.
2. Heavy impacts / Doors open / Hood open / Trunk open / Turn on the ignition key / Activate PIR sensor / Activate door/window sensor will trigger the programmed sequence.

The starter disable relay (if installed) prevents the vehicle's starter from cranking. The siren, horn, parking lights, and dome light will turn on to alerting of an intrusion for 30 seconds. Then it will stop and automatic

reset and re-arm. If the one of sensors or detectors still active, the alarm system will sound a maximum of 3 times of 60 seconds cycles.

NOISE ABATEMENT CIRCUIT: Your system has "Noise Abatement Circuit". It prevents annoying repetitive trigger sequences due to faulty door pin switches or environmental condition such as thunder, jackhammers airport noise, etc.



Here's how "Noise Abatement Circuit" works: The alarm triggers five times. Each time, the same sensor or switch is triggering the alarm. "Noise Abatement Circuit" will interpret this pattern of triggers as false alarm. After the fifth trigger, "Noise Abatement Circuit" ignores, or by pass, that sensor or switch until the other sensor or switch is trigger.

Doors (Hood/Trunk) are covered by "Noise Abatement Circuit" differently: If the alarm is triggered by an open door for six full cycles (three minutes), the doors will be bypassed until the trigger ceases.

N. ANTI CAR-JACKING

Warning: If you don't need the car jacking function in this alarm system, be sure to set car jacking feature "OFF". This system is default setting all car-jacking "OFF". (See Alarm Feature **I - 4** Programming.)

ACTIVE ANTI CAR JACKING:

1. Press and hold the transmitter  and  button at the same time for 2 seconds while the vehicle's ignition is ON. The parking lights will turn on for 1.5 seconds to indicate this enter.
2. Once the system is armed, If you are forced from the vehicle, the system will trigger when the door is opened and closed while the ignition is "ON".

PASSIVE ANTI CAR- JACKING:

It operate as below:

1. Turn the ignition switch to "ON" position, the system will arm.
2. Once the system is armed, If you are forced from the vehicle, the system will trigger when the door is opened and closed while the ignition is "ON".

TRIGGER THE ANTI CAR JACK MODE:

3-timer circuits will function as follows:

First timer: a. 50 seconds after the system has been triggered. The siren will start chirping for 15 seconds.
b. During this 15 seconds period of chirping, you will be alerting to push the valet switch once to turn off the car-jacking feature.
c. If not, it will enter second timer car jacking.

Second timer: 65 seconds after the system has been triggered. The siren starts alarming and the parking light starts flashing.

Third timer: 90 seconds after the system has been triggered

- a. The siren still alarming and the parking light flashing, and
- b. The starter disable will activate to prevent the vehicle from starting.
- c. It will remain active until the vehicle's battery power exhausted.

OVERRIDE THE SYSTEM TO TURN OFF ANTI CAR JACKING:

Turn the ignition switch from OFF to ON, and within 10 seconds push valet switch, the siren will stop and the system disarmed

Note: If you use password pin code to double protect the vehicle security, you will need to use it to completely disarm the system.

O. DOME LIGHT CONVENIENCE DELAY & SUPERVISION

The alarm with a unique feature which will turn on your vehicle dome light as following:

1. Upon disarming, the interior lights will remain on for 30 seconds.
2. If the vehicle is intruded, the interior light will flash for the same duration as the siren.

Note: Turn ON the ignition switch or arm the alarm will turn off the dome light.

P. IGNITION CONTROL POWER DOOR LOCK SAFETY SYSTEM. (See Feature **II - 3/4** Programming.)

1. Turn the ignition switch on and close all vehicle's doors. After 3 seconds, the system will automatically lock the central locking system.
2. Turn the ignition switch off. The system will automatically unlock the central locking system.

Q. TRUNK RELEASE (Factory default setting) / CHANNEL 3 TIMER CONTROL



OUTPUT. (See Alarm Feature **III - 3** Programming.)

Press and hold the  button on transmitter for two seconds to remote control the trunk release or other electric devices.

Channel 3 is user-programmable timer output. You may program the built-in timer to send a ground signal for any time interval between 1 second and 2 minutes. For instance, this timer output may be used to turn on the headlight, power window or sunroof.

Note: Factory default setting at 1 second pulse grounded for trunk release output.

R. CHANNEL 4 TIMER CONTROL OUTPUT (See Alarm Feature **III - 5** Programming.)

Press the transmitter  and  button at same time to active Channel 4 function.

Channel 4 is user-programmable timer output. You may program the built-in timer to send a ground signal for any time interval between 1 second and 2 minutes. For instance, this timer output may be used to turn on the headlight, power window or sunroof.

Note: Factory default setting at momentary output.

S. POWER ON MEMORY:

This security system is equipped with circuitry that will allow the unit to remember its alarm state if the power is lost and then reconnected.

This device complies with part 15 of the FCC rules. Operation is subject to the following two conditions.

- (1) This device may not cause harmful interference, and
- (2) This device must accept any interference received, including interference that may cause undesired operation.

